

Damocles

Damocles2 family

Damocles2 is a family of products for remote monitoring and control of a LAN.

The family consists of several versions designed for different uses (19" cabinets, data centers, electric cabinets, ...). Individual Damocles2 models differ in the number of inputs and outputs. Other features are identical.

In case of any trouble with installation and getting started please contact our technical support:

HW group s. r. o.
<http://www.hw-group.com>
E-mail: support@HWg.cz
Phone: +420 222 511 918

Formanská 296
Prague 4, 149 00
Czech Republic

Before contacting our technical support please have ready the exact type of your device (on the product label) and also the firmware version, if you know it.

Table of contents

Damocles2 models	4
Damocles2 MINI	4
Damocles2 1208	5
Damocles2 2404	6
Feature comparison	7
Connectors	8
First start	9
Connecting the cables	9
Configuring the IP address – UDP Config	9
Configure the network parameters	10
WWW interface of the device	11
Web interface of the device	12
Common features of the Damocles2 family	24
Displayed readings	24
Supported interfaces (in detail)	24
DI (Digital Inputs) – Dry contact Inputs	24
DO (Digital Outputs)	25
User interface	27
HWg config	27
WEB interface	28
Updating Firmware	56
Software applications	57
HWg-PDMS	57
HWg-Trigger	57
SensDesk.com	58
PosDamIO and SDK	59
Specifications	60
Damocles2 MINI dimensions	60
Damocles2 MINI specifications	61
Damocles2 1208 dimensions	62
Damocles2 1208 specifications	63
Damocles2 2404 dimensions	64
Damocles2 2404 specifications	65
Formats and interfaces	66

Damocles2 models

Damocles2 MINI

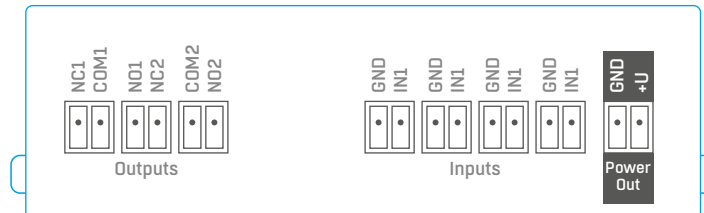
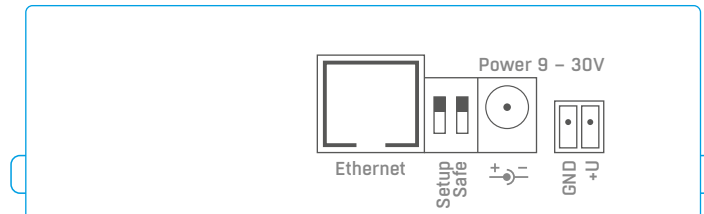
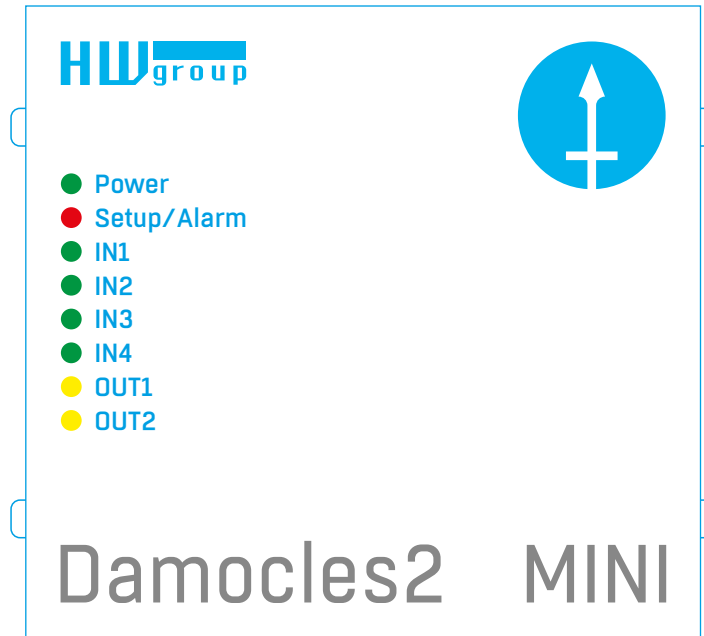

Damocles2 1208

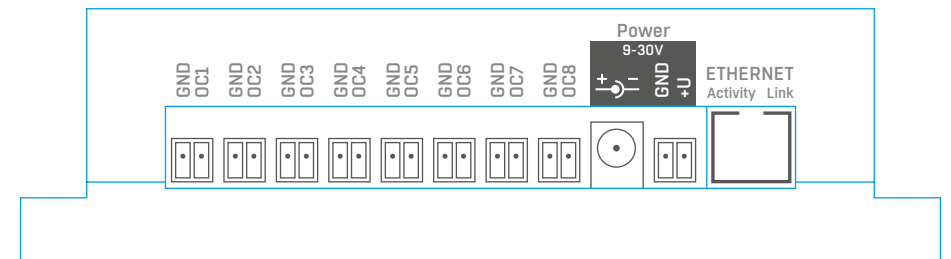
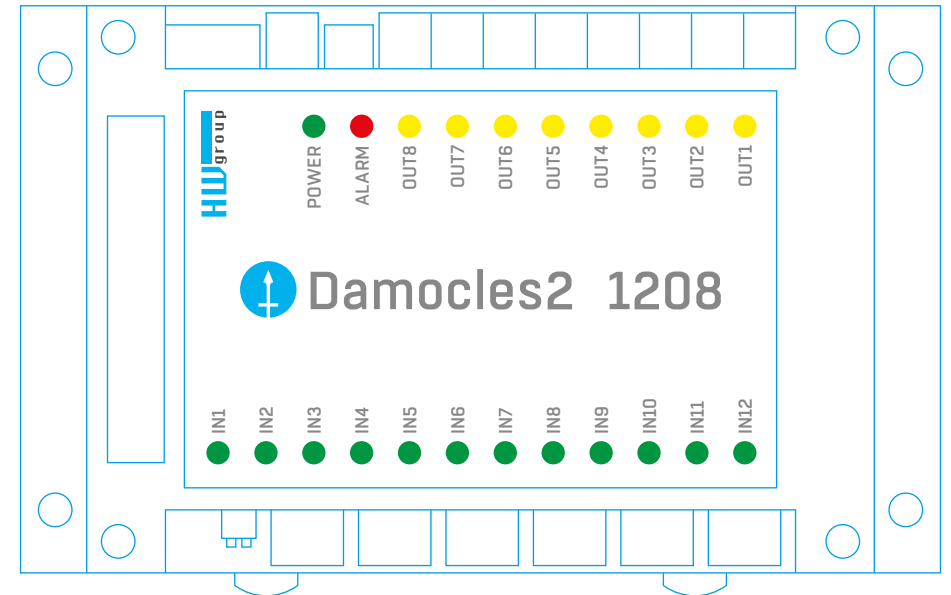
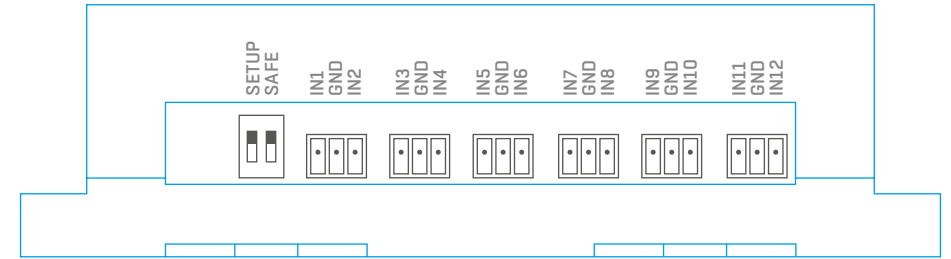

Damocles2 2404

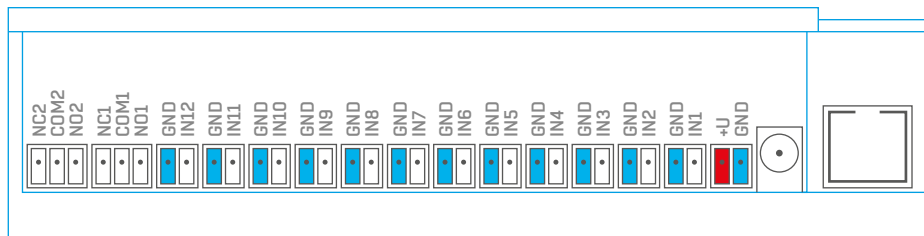
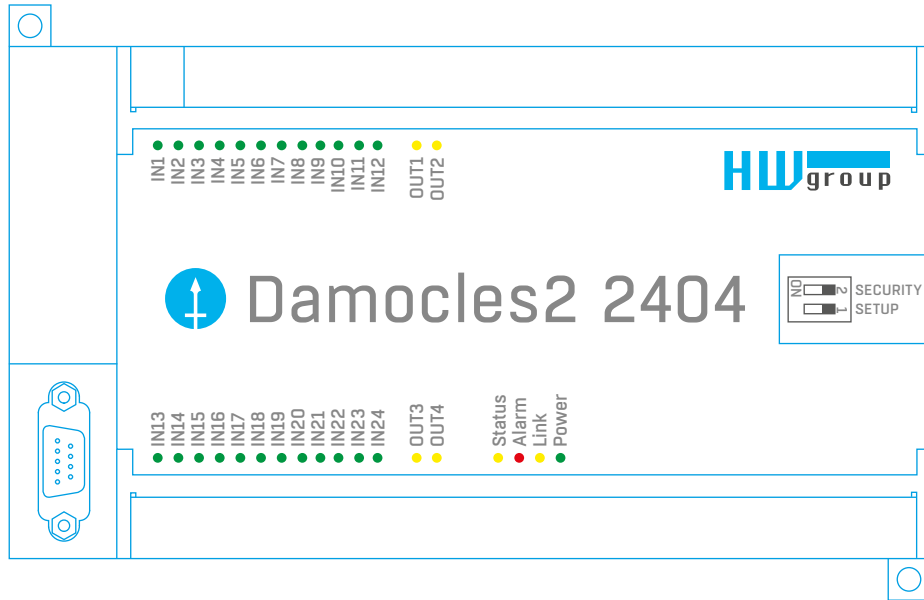
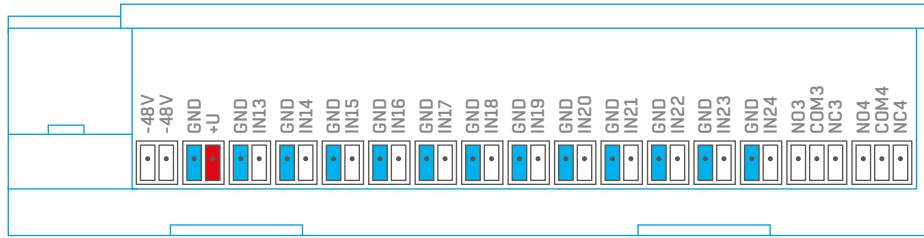

Feature comparison

	Damocles2 MINI	Damocles2 1208	Damocles2 2404
DI (digital inputs)	4	12	24
Pulse counter (SD) on DI	Yes	Yes	Yes
Non-volatile counter memory	Yes	Yes	Yes
DO (digital outputs)	2	8	4
DO type	50 V / 1A relay	OC (open collector)	50 V / 1A relay
Pulse output	Yes	Yes	Yes
VDD (virtual digital outputs)	Yes	Yes	Yes
Power	9 – 30 V	9 – 30 V	9 – 30 V
PoE (IEEE 802.3af)	No (upon request)	No (upon request)	Yes
-48 V (Telco)	No	No	Yes
SNMP protokol	Yes	Yes	Yes
SNMP v3 (SSL security)	Yes	Yes	Yes
SNMP Traps	Yes	Yes	Yes
SMTP protokol (TLS support)	Yes	Yes	Yes
MQTT protokol	Yes	Yes	Yes
IPv6 protokol	Yes	Yes	Yes
HTTPS protokol (certificate upload)	Yes	Yes	Yes
Modbus / TCP	Yes	Yes	Yes
HWg-PUSH (SensDesk protokol)	Yes	Yes	Yes
NotGSM (SMS-GW protokol)	Yes	Yes	Yes
Box-2-Box 4 (SNMP protokol for VDD)	Yes	Yes	Yes
Box-2-Box 16 (HTTP protokol for VDD)	Yes	Yes	Yes
External modem (RS-232)	No	No	Yes
Material, form factor	Metal	Plastic (DIN rail)	Plastic (DIN rail)
Device dimensions	106×94×31 mm	145×90×40 mm	116×179×46 mm

Connectors

Ethernet

Ethernet 100Base-Tx (10/100Mbit). When connected, the green “Link” LED at the connector lights up to indicate proper connection. When communicating, the yellow „Activity” LED flashes.

Power

The green LED indicates that the device is powered. Upon request (and under a different product code), Damocles2 models other than 2404 can be also equipped with PoE (Power over Ethernet).

Inputs

INx – dry contact inputs. Inputs always share a common ground (GND). The corresponding green LED indicates a closed contact.

Outputs

- **Damocles2 MINI** – OUTx – relay outputs with NO/NC contacts. When idle, NCx (Normally Closed) + COMx (Common) are connected. When activated, NOx (Normally Open) + COMx are connected. Yellow LED indicates an activated output.
- **Damocles2 2404** – OUTx – relay outputs with NO/NC contacts. When idle, NCx (Normally Closed) + COMx (Common) are connected. When activated, NOx (Normally Open) + COMx are connected. Yellow LED indicates an activated output.
- **Damocles2 1208** – open collector – semiconductor outputs with a common ground (GND), for controlling external switching elements. Yellow LED indicates an activated output. For more information, see *Open Collector – Damocles2 1208 only*.

Alarm/Setup LED

Red LED indicates device state: continuously on means Alarm (DI outside of the safe range), flashing means TCP or Serial Setup mode.

DIP1/DIP2 switches

DIP1 – activates serial setup mode/restores factory defaults. To restore factory defaults, quickly toggle the switch 3× within the first 5 seconds after powering up the device.

DIP2 – safe mode – activates HW protection of configuration settings. In Safe mode, parameters cannot be changed (online demo).

First start

First steps

1. Connecting the cables

- Turn the unit and note its MAC address that is printed on the label on the side.
- Set the switches: **DIP1=Off**, **DIP2=Off**.
- Connect the unit to the Ethernet (with a patch cable to a switch, cross-over cable to a PC), RJ-45 port.
- Plug the power adapter into an electricity outlet and connect it to the Damocles2 power connector.
- The green **POWER** LED lights up.
- If the Ethernet connection works properly, the **LINK** LED lights up after a short while, and then flashes whenever data are transferred (activity indication)

2. Configuring the IP address – UDP Config

HWg Config utility – root directory of the supplied CD (Windows and Linux versions).

Also available for download at www.HW-group.com -> [Software](#) -> [UDP Config](#).

- Click the icon to launch **HWg Config**. The program automatically looks for connected devices.
- Automatic device discovery works only in the local network.
- Individual Damocles2 units are identified by their MAC addresses (on the label at the bottom).
- Double-click a MAC address to open a basic device configuration dialog.

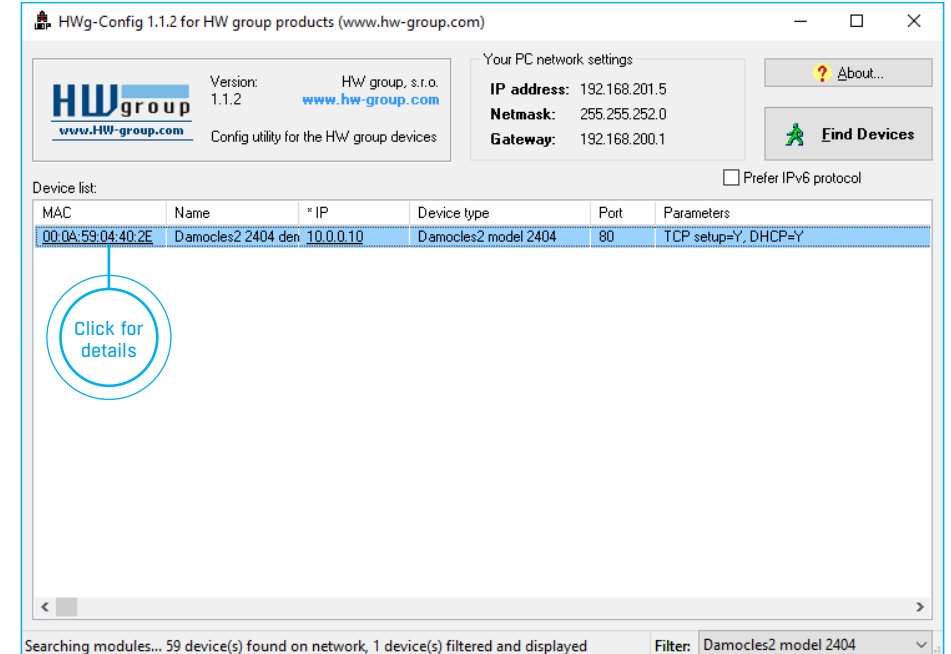

3. Configure the network parameters

- IP address / HTTP port (80 by default)
- Network mask
- Gateway IP address for your network
- Device name (optional)

Click the **Apply Changes** button to save the settings.

Alternatively, you may use the following utilities to configure the IP address:

- [HWg Config for Linux](http://hw-group.us/product-version/udp-config-linux) – available for download at:

Important

- To reset the device to factory defaults, toggle DIP1 several times within 5 seconds after applying power to the device.
- No configuration changes can be stored while DIP2=On. To change the IP address, set DIP2=Off.

4. WWW interface of the device

- **To open the WWW interface of the device:**
 - Enter the device IP address in a web browser
 - Click the IP address in UDP Config
 - Click the underlined IP address in UDP SETUP
- The WWW page displays current status of the device and its digital inputs

Web interface of the device

- General:** Overview of current readings
- General Setup:** IP address, DNS
- Security:** IP filter, security (username/password), HTTPS certificates
- SNMP:** SNMP/SNMP Trap configuration (ports and alarm recipients)
- Modbus:** Enabling Modbus/TCP communication
- E-mail:** Configuration and test
- GSM:** Configuration and test when working with a remote SMS-GW
- Log & Time:** Time configuration, NTP server
- Portal:** Connection to a remote portal
- Inputs:** Control of inputs and alert parameters
- Outputs:** Control of outputs, setting of parameters
- Virtual Outputs:** Option to control outputs via a Poseidon2 and Damocles2, B2B
- System:** Firmware upgrade, save/restore configuration, etc.

General

Damocles2 2404 GENERAL

Digital Inputs (DI)

Name	ID	Current Value	Alarm Alert	Counter
Binary 1	1	0(Off)	Disabled	0
Binary 2	2	0(Off)	Disabled	0
Binary 3	3	0(Off)	Disabled	0
Binary 4	4	0(Off)	Disabled	0
Binary 5	5	0(Off)	Disabled	0
Binary 6	6	0(Off)	Disabled	0
Binary 7	7	0(Off)	Disabled	0
Binary 8	8	0(Off)	Disabled	0
Binary 9	9	0(Off)	Disabled	0
Binary 10	10	0(Off)	Disabled	0
Binary 11	11	0(Off)	Disabled	0
Binary 12	12	0(Off)	Disabled	0
Binary 13	13	0(Off)	Disabled	0
Binary 14	14	0(Off)	Disabled	0
Binary 15	15	0(Off)	Disabled	0
Binary 16	16	0(Off)	Disabled	0
Binary 17	17	0(Off)	Disabled	0
Binary 18	18	0(Off)	Disabled	0
Binary 19	19	0(Off)	Disabled	0
Binary 20	20	0(Off)	Disabled	0
Binary 21	21	0(Off)	Disabled	0
Binary 22	22	0(Off)	Disabled	0
Binary 23	23	0(Off)	Disabled	0
Binary 24	24	0(Off)	Disabled	0
Comm Monitor 1	123	0(Off)	Disabled	4294967295

Digital Outputs (DO)

Name	ID	Current Value	Mode
BinOut 1	151	0(Off)	Manual
BinOut 2	152	0(Off)	Manual
BinOut 3	153	0(Off)	Manual
BinOut 4	154	0(Off)	Manual
VirtBinOut 1	1151	0(Lock)	Manual

Terminal Config (TCP Setup)

SNMP MIB: Connect with telnet: to:

SNMP Object Identifier:

XML Schema Definiton:

- 1 User-defined DI names
- 2 Alarm thresholds
- 3 Action when value out of range
- 4 MIB file for SNMP software

Note: For a detailed description, see the detailed web interface description (2nd half of the manual).

General setup

Damocles2 2404 GENERAL SETUP

Device

Name	Value
Device Name:	Damocles2 2404

Network Settings

Name	Value
IP Address:	192.168.100.66
Submask:	255.255.255.0
Gateway:	192.168.100.1
Primary DNS:	192.168.100.253
Secondary DNS:	192.168.100.250
HTTP Port:	80 0=dis, def 80
HTTPS Port:	443 0=dis, def 443
TCP Telnet Setup:	99 0=dis, def 99
DHCP Client:	<input checked="" type="checkbox"/>

IPV6

Name	Value
Enable IPV6:	<input type="checkbox"/>
Autoconfig IP parameters:	
Link Local Address:	
IP Address / Prefix length:	
Gateway:	
Primary DNS:	
Secondary DNS:	

Other settings and information

Name	Value
Syslog IP Address:	0.0.0.0
HW Security Protection:	Disabled

Counters

Name	Value
Counters enable:	<input checked="" type="checkbox"/>
All counters reset :	<input type="button" value="Reset"/>

Version: 3.0.8

- 1 Device name, e. g. "First floor 1"

Note: For a detailed description, see the detailed web interface description (2nd half of the manual).

Security

- 1 Filters for IP addresses which may access the device
- 2 Configuration of usernames and passwords for accessing the device
- 3 HTTPS certificates

Note: For a detailed description, see the detailed web interface description (2nd half of the manual).

SNMP

- 1 Changes SNMP protocol versions
- 2 5 destinations for SNMP Traps

Note: For a detailed description, see the detailed web interface description (2nd half of the manual).

E-mail

Damocles2 2404 EMAIL

Email Settings

Name	Value
SMTP Server:	some.smtp.server [IP Address or DNS Name]
SMTP port:	25
Email Sender Address:	user@domain.com
Authentication:	<input type="checkbox"/>
Secure TLS mode:	<input type="checkbox"/>
Name/Password:	User login name /
Email Subject Text:	Subject_0

Email Destinations

Name	Value
Alarm Email Recipient:	To0@domain.com
Alarm Email Copy:	To1@domain.com
Alarm Email Copy:	To2@domain.com
Alarm Email Copy:	To3@domain.com
Alarm Email Copy:	To4@domain.com
Periodic Log Recipient:	To5@domain.com

Test Email

Name	Value
State:	

Periodic Status Settings

Name	Value
Periodical Status:	<input type="checkbox"/> Period: 60 [minutes]
Alarm reminder:	<input type="checkbox"/> Period: 5 [minutes]

Version: 3.0.8

Apply Changes

- 1 This text is inserted at the beginning of the e-mail subject line
- 2 Up to 5 recipients of alarm e-mails
- 3 E-mail test result
- 4 Sends a test E-mail

Periodic Status Settings

- **Periodical Status** – when enabled, sends an e-mail with device status at the specified intervals. For example every 24 hours (1440 minutes).
- **Alarm Reminder** – when active, sends periodic reminders that the device is in the Alarm state. For example every 15 minutes.

To send e-mail, check:

1. Correct **Gateway IP** address
2. **DNS server** in the network settings
3. **SMTP server** and port
4. **Authentication** enabled, correct **username** and **password**
5. **Spam filter** for your mailbox is disabled

GSM

Damocles2 2404 GSM

Serial Port Settings

Name	Value
Port Function:	Disabled

Remote SMS gateway

Name	Value
Enable:	<input type="checkbox"/>
IP Address or DNS Name:	192.168.1.36
Link/Path:	service.xml
Port:	80
Username:	
Password:	

GSM SMS Interface

Name	Value
GSM Function:	Remote
SMS + Ring When Alarm:	<input type="checkbox"/>

GSM SMS Recipients

Name	Value	Test
Alarm SMS Recipient 1:		
Alarm SMS Recipient 2:		Send Test SMS
Alarm SMS Recipient 3:		
Alarm SMS Recipient 4:		Ringout Test
Alarm SMS Recipient 5:		

Version: 3.0.8

Apply Changes

- 1 IP address of "HWg-SMS-GW" to use for sending text messages (SMS)
- 2 Recipients' phone no's

Note: We recommend to use HWg-SMS-GW3 for sending text messages. One central SMS gateway for all HW group devices in a single LAN.

Log & Time

- 1 Press the button to manually synchronize time with the specified server
- 2 Interval for logging measured values
- 3 Expected size of recorded data

Portal

- 1 Message from the portal
- 2 Enable connection to the remote portal
- 3 Click to connect to the portal
- 4 AutoPush configuration

Configures the communication with the portal using the HWg-Push protocol. Damocles2 is the active side and establishes the connection periodically and/or whenever a change in a sensor value exceeds the configured AutoPush value.

Connection parameters for the www.SensDesk.com portal are pre-filled.

AutoPush configuration

Whenever an input state changes, Damocles2 immediately connects to the portal and notifies the DI change. (In case of sensors, the change must exceed the AutoPush value.)

This configuration only applies to the communication between Damocles2 and the online portal. Local alarm values are configured in the portal.

For portal connection, check:

1. Correct **Gateway IP** address
2. **DNS server** in network settings
3. Correct **Server Address** of the portal

Digital Inputs (DI)

Name	ID	Current Value	Alarm	Delay[s]	SNMP Trap	Email	SMS
Binary 1	1	0(Off)	Active if on	0	<input type="checkbox"/>	<input checked="" type="checkbox"/>	<input checked="" type="checkbox"/>
Binary 2	2	0(Off)	Disabled	0	<input type="checkbox"/>	<input type="checkbox"/>	<input type="checkbox"/>
Binary 3	3	0(Off)	Disabled	0	<input type="checkbox"/>	<input type="checkbox"/>	<input type="checkbox"/>
Binary 4	4	0(Off)	Disabled	0	<input type="checkbox"/>	<input type="checkbox"/>	<input type="checkbox"/>
Binary 5	5	0(Off)	Disabled	0	<input type="checkbox"/>	<input type="checkbox"/>	<input type="checkbox"/>
Binary 6	6	0(Off)	Disabled	0	<input type="checkbox"/>	<input type="checkbox"/>	<input type="checkbox"/>
Binary 7	7	0(Off)	Disabled	0	<input type="checkbox"/>	<input type="checkbox"/>	<input type="checkbox"/>
Binary 8	8	0(Off)	Disabled	0	<input type="checkbox"/>	<input type="checkbox"/>	<input type="checkbox"/>
Binary 9	9	0(Off)	Disabled	0	<input type="checkbox"/>	<input type="checkbox"/>	<input type="checkbox"/>
Binary 10	10	0(Off)	Disabled	0	<input type="checkbox"/>	<input type="checkbox"/>	<input type="checkbox"/>
Binary 11	11	0(Off)	Disabled	0	<input type="checkbox"/>	<input type="checkbox"/>	<input type="checkbox"/>
Binary 12	12	0(Off)	Disabled	0	<input type="checkbox"/>	<input type="checkbox"/>	<input type="checkbox"/>
Binary 13	13	0(Off)	Disabled	0	<input type="checkbox"/>	<input type="checkbox"/>	<input type="checkbox"/>
Binary 14	14	0(Off)	Disabled	0	<input type="checkbox"/>	<input type="checkbox"/>	<input type="checkbox"/>
Binary 15	15	0(Off)	Disabled	0	<input type="checkbox"/>	<input type="checkbox"/>	<input type="checkbox"/>
Binary 16	16	0(Off)	Disabled	0	<input type="checkbox"/>	<input type="checkbox"/>	<input type="checkbox"/>
Binary 17	17	0(Off)	Disabled	0	<input type="checkbox"/>	<input type="checkbox"/>	<input type="checkbox"/>
Binary 18	18	0(Off)	Disabled	0	<input type="checkbox"/>	<input type="checkbox"/>	<input type="checkbox"/>
Binary 19	19	0(Off)	Disabled	0	<input type="checkbox"/>	<input type="checkbox"/>	<input type="checkbox"/>
Binary 20	20	0(Off)	Disabled	0	<input type="checkbox"/>	<input type="checkbox"/>	<input type="checkbox"/>
Binary 21	21	0(Off)	Disabled	0	<input type="checkbox"/>	<input type="checkbox"/>	<input type="checkbox"/>
Binary 22	22	0(Off)	Disabled	0	<input type="checkbox"/>	<input type="checkbox"/>	<input type="checkbox"/>
Binary 23	23	0(Off)	Disabled	0	<input type="checkbox"/>	<input type="checkbox"/>	<input type="checkbox"/>
Binary 24	24	0(Off)	Disabled	0	<input type="checkbox"/>	<input type="checkbox"/>	<input type="checkbox"/>
Comm Monitor 1	123	0(Off)	Disabled	0	<input type="checkbox"/>	<input type="checkbox"/>	<input type="checkbox"/>

- Enter Digital Input name that will be shown in E-mails, text messages or SNMP traps
- Alarm contact status:
 - Active if On
Alarm when the contact is closed (1 = On)
 - Active if Off
Alarm when the contact is open (0 = Off)
 - Disabled
No Alarm
- Reaction to digital inputs:
 - Send a SNMP Trap
 - Send an E-mail
 - Send a SMS
 - Nothing checked = no active alarm on the DI

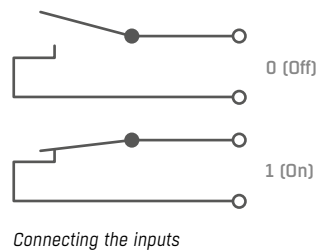

- Damocles2 notifies alarm activation/deactivation for each DI.
- E-mail format cannot be changed, except that inputs may have custom names.
- Yellow background of the line with a sensor or an input means that the safe range is exceeded but alarm notification is off.

Digital Outputs (DO)

- Choose the output mode
Manual mode: Output controlled over the WEB or M2M protocols
Local Condition mode: Controls the output according to the specified input
- Enter a DO name to show in E-mails, text messages or SNMP traps
- Pulse output timer [s].
By default, **Pulse Timer = 0** for a standard output

Pulse Timer

When set, the output is activated only for a specified duration. Pulse Timer = 0 disables this function. For details, see the WEB interface description.

Output mode:

- Manual** – DO can be controlled using the Web interface or externally using M2M protocols. DO cannot be used in “thermostat” mode – local condition.
- Local Condition** – DO cannot be controlled over the Web, it is controlled by a condition. DO is read-only for all M2M protocols. Hysteresis in the sensor settings applies. In the Local Condition mode, outputs cannot be controlled over the WEB or using M2M protocols.
 - On if any alarm** – DO = On, if at least one input or sensor is in alarm.
 - On if value equal to Trigger** – DO = On, if the selected sensor reading **is equal** to the “Target Value”.
 - On if value higher than Trigger** – DO = On, if the selected sensor reading **is higher than** the “Target Value”.
 - On if value lower than Trigger** – DO = On, if the selected sensor reading **is less than** the “Target Value”.
 - On if alarm on** – DO = On when a particular sensor or input is in the Alarm state.
 - Dependent On** – sensor/input to which the condition applies.

Virtual Outputs (VDO)

Virtual Outputs allow the use of outputs of other Poseidon2 or Damocles2 units (Box2Box). The communication uses the TCP protocol and updates take place every 60s. For more information, see *Web interface – Virtual Outputs*.

System

1 Restores factory defaults

2 Uploads new firmware from the PC

Configuration

- **Download** – download the configuration from the device to the PC.
- **Upload** – restore the configuration from the PC to the device.

Note: Configuration changes must be confirmed by clicking the *Apply Changes* button.

Common features of the Damocles2 family

Displayed readings

- Damocles2 displays current values of all digital inputs (DI).
- Inputs feature pulse counters for connecting energy meters with SO outputs.
- An input is considered active (for Alarm state purposes) if it is closed for more than approx. 900ms (inputs are sampled approximately every 30 ms because of SO).
- Alarm state can be set independently for each input (contact).
- If the Alarm is not assigned to any channel (SMS, Email, SNMP Trap), the alarm is not notified and the corresponding line is highlighted in yellow at the first page (General).
- Upon Alarm, the device can send a SNMP Trap, E-mail, or SMS.
- Damocles2 notifies both the beginning and the end of an alarm (contact closing and contact opening).
- Supports a shared HWg-SMS-GW3 gateway for texting.
- Supports SNMPv1 and SNMPv3.
- Supports e-mail authentication via TLS.

Supported interfaces (in detail)

DI (Digital Inputs) – Dry contact Inputs

Dry (voltage-free) contacts can be connected to these terminals. For example door contacts. The inputs are electrically connected to the power supply.

- Unconnected inputs read as “0 (Off)”.
- Activated inputs (closed contacts) read as “1 (On)”, resistance against the Common pin must not exceed 500 Ω.

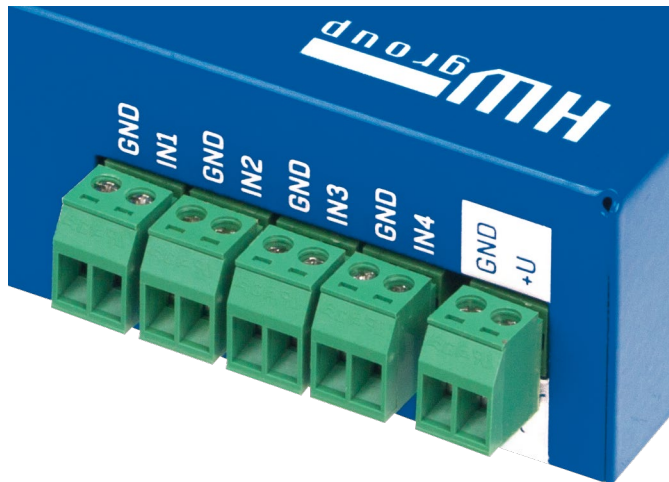

Specifications:

- **Maximum wiring length:** 50 m
- **Supported sensors:** Any contact without external voltage (dry contact)
- **Alarm settings for each DI:**
 - Alarm inactive
 - Alarm when the contact is open or closed
 - Alarm when the contact is open
- **Possible alarm responses:** Common setting for all inputs
 - No response
 - Alarm alert sent as a SNMP trap
 - Alarm alert sent by e-mail or text message (SMS)
 - Alarm alert sent as a SNMP trap as well as by e-mail or SMS
- **Polling period:** approx. 900 ms
- **Range of sensor IDs:** DI (Digital Inputs) use ID addresses from 1 to 24
- **Input names:** Each DI can be named using up to 12 characters
- **Disconnected detector indication:** None, disconnected detectors read as “0 (Off)”

DO (Digital Outputs)

Damocles2 units feature various types of digital outputs:

- **Damocles2 MINI** – Relay
- **Damocles2 1208** – Open Collector
- **Damocles2 2404** – Relay

Relay Output

Each output controls two relay contacts: one “Normally Open” (NO) contact (open when the power is off and after startup), and one “Normally Closed” (NC) contact (closed when the power is off and after startup).

Contact state (closed / open) is indicated by the corresponding LED.

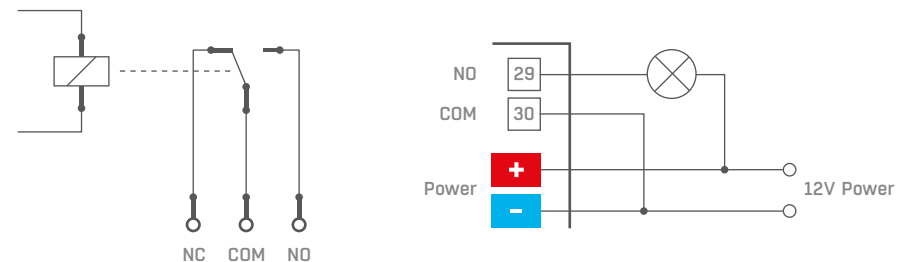

The picture shows an example of connecting a 12V light bulb, powered from the same source as the unit and controlled by the Normally Open contact of output No. 4.

Open Collector – Damocles2 1208 only

Open collector outputs with common overvoltage diode protection. Outputs are protected with internal diodes against voltage spikes (e.g. from relay coils).

- **Maximum load:** 50 V, 500 mA per output, max. 1500 mA total for all outputs
- **Output names:** Each output can be named using up to 12 characters
 - **State names:** Output state (On and Off) can be named with up to 6 characters (e.g. “Fuel Tank 14” “Full”/“Empty”)

Output devices can be powered from the same power supply as Damocles, or from another source. **It is necessary to connect the power for external devices accordingly:**

A Connecting the outputs – internal power supply

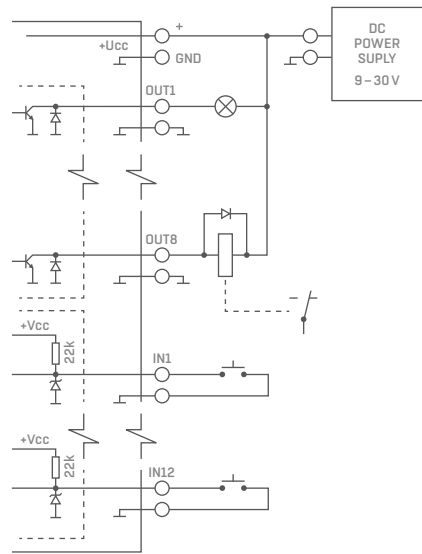

B Connecting the outputs – external power supply

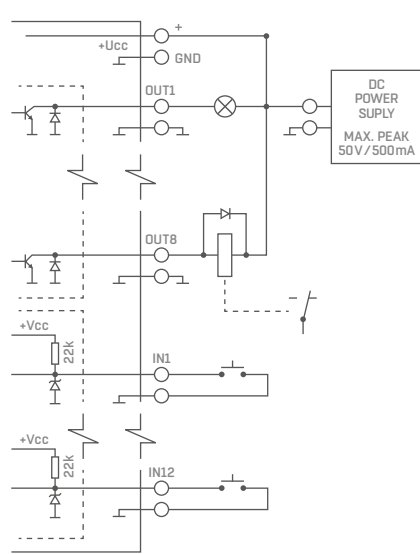

Connecting Damocles2 1208 units (OC outputs) to Poseidon2 (DI inputs)

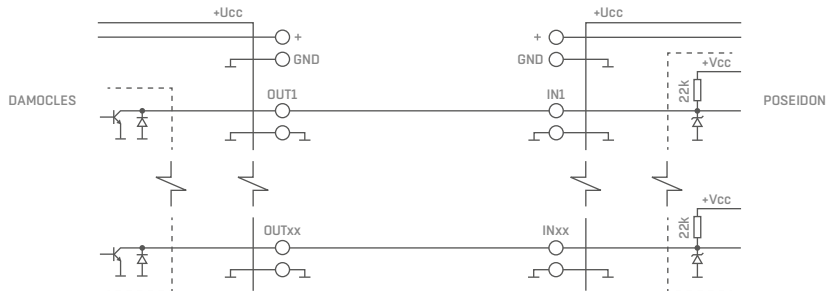

User interface

HWg Config

HWg Config is a freeware utility for finding devices, assigning IP addresses and changing network settings over the Ethernet.

- Windows and Linux version
- IP address is assigned to a product with a specific MAC address
- No installation is necessary, simply run the EXE file
- Provides a clear overview of device names and parameters

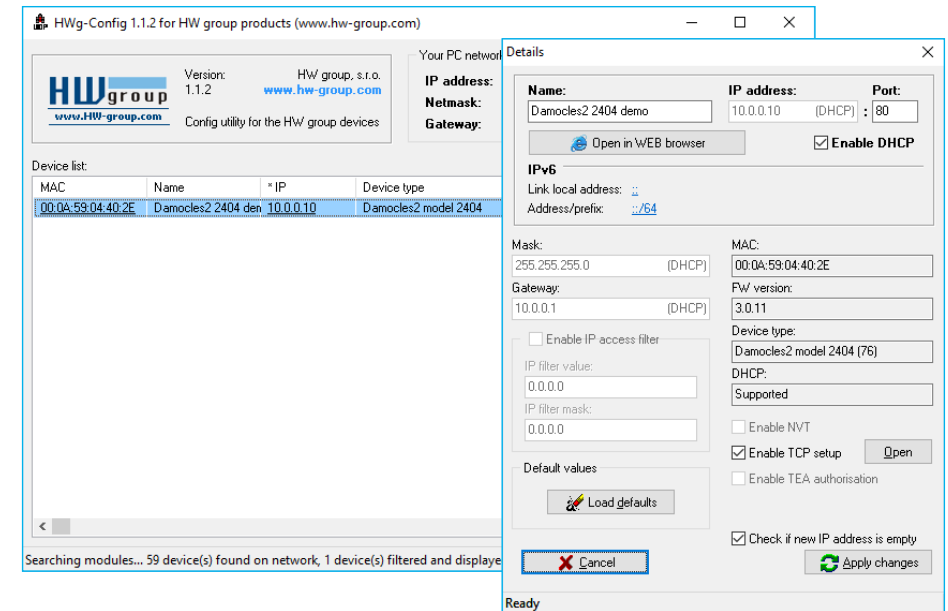

Main features

- Concise graphical environment
- Device name, type, MAC address, IP address and communication port is displayed after a device is found
- Compatible with all HW group products (Poseidon, Damocles, PortBox, PortStore, I/O Controller, IP relay and other product lines)
- Windows and Linux versions available
- Displays current network settings of your computer
- Checks if the IP address is in use before assigning it
- Single-click access to the device web page
- Ability to open a Telnet session for TCP Setup
- Ability to restore factory defaults

Detailed program description as well as an instructional video clip are available on the CD supplied with the device, or at our website: http://www.hw-group.com/software/udp_config/index_en.html

Web interface

Main communication interface

Damocles2 offers a simple and user-friendly graphical WWW interface. Besides displaying current readings, the interface provides access to complete device configuration and management, including network settings, sensor configuration and alarm responses (SNMP traps).

To access the web interface, enter the Damocles2 IP address into the URL field of your browser and press Enter:

General

Damocles2 2404 GENERAL

Digital Inputs (DI)

Name	ID	Current Value	Alarm Alert	Counter
Binary 1	1	0(Off)	Disabled	0
Binary 2	2	0(Off)	Disabled	0
Binary 3	3	0(Off)	Disabled	0
Binary 4	4	0(Off)	Disabled	0
Binary 5	5	0(Off)	Disabled	0
Binary 6	6	0(Off)	Disabled	0
Binary 7	7	0(Off)	Disabled	0
Binary 8	8	0(Off)	Disabled	0
Binary 9	9	0(Off)	Disabled	0
Binary 10	10	0(Off)	Disabled	0
Binary 11	11	0(Off)	Disabled	0
Binary 12	12	0(Off)	Disabled	0
Binary 13	13	0(Off)	Disabled	0
Binary 14	14	0(Off)	Disabled	0
Binary 15	15	0(Off)	Disabled	0
Binary 16	16	0(Off)	Disabled	0
Binary 17	17	0(Off)	Disabled	0
Binary 18	18	0(Off)	Disabled	0
Binary 19	19	0(Off)	Disabled	0
Binary 20	20	0(Off)	Disabled	0
Binary 21	21	0(Off)	Disabled	0
Binary 22	22	0(Off)	Disabled	0
Binary 23	23	0(Off)	Disabled	0
Binary 24	24	0(Off)	Disabled	4294967295
Comm Monitor 1	123	0(Off)	Disabled	0

Digital Outputs (DO)

Name	ID	Current Value	Mode
BinOut 1	151	0(Off)	Manual
BinOut 2	152	0(Off)	Manual
BinOut 3	153	0(Off)	Manual
BinOut 4	154	0(Off)	Manual
VirtBinOut 1	1151	0(Lock)	Manual

Terminal Config (TCP Setup)

Connect with telnet 192.168.100.66 Port 99

SNMP MIB: MIB
 SNMP Object Identifier: OID
 XML Schema Definition: XSD

Version: 3.0.8
 Reload values every [s]
 Values reloaded 40

For more information try <http://www.hw-group.com/>

The main page with the overview of DI and DO states automatically reloads at configurable intervals (by default every 10 seconds, can be changed easily).

Inputs

This section displays current states of dry contact inputs, including alarm states and settings. Active alarm is indicated by a **red background** of the corresponding line.

- **Name** – Textual name of the input, assigned by user at the Inputs tab.
- **ID** – Unique input ID number, as marked on the unit.
- **Current Value**
 - **0 (Off)** – Open contact.
 - **1 (On)** – Closed contact.
- **Alarm Alert** – List of alarm settings for each input (triggered by values out of safe range).
- **Line background color:**
 - **White / no color** = Input is not in alarm.
 - **Red** = Input is in alarm.
 - **Yellow** = Alarm is disabled for this input but the value is out of the safe range.
- **Counters** – Damocles inputs feature pulse counters. This can be used for example to read energy consumption meters with a pulse output (SO). Counters are incremented whenever the input is closed. The pulse must be longer than 20 ms to be registered.

Outputs

Displays current output states, including their modes.

- **Name** – Textual name of the output, assigned by user at the Outputs tab.
- **ID** – Unique output ID number, as marked on the unit.
- **Current Value**
 - **0 (Off)** – Output is idle (open, that is COM + NO connected).
 - **1 (On)** – Output is active (closed, that is COM + NC connected).
- **Mode** – Output mode, configured at the Outputs tab.

Other information

- **Terminal Configuration (TCP Setup)** – Link containing the IP address and the port to open a terminal session for TCP Setup.
 - **MIB** links to the SNMP definition file. (right-click the link and select “Save Target as...” to save the file to disk).
 - **OID** – SNMP Object Identifier, contains the list of most frequent SNMP OIDs. (right-click the link and select “Save Target as...” to save the file to disk).
 - **XSD** links to the XML definition file for **values.xml**. (right-click the link and select “Save Target as...” to save the file to disk).
- **Text and link** “For more information try www.hw-group.com”. Customizable link to the supplier or service provider. The text can be changed in TCP Setup, see the detailed description of *TCP Setup*.

Note: The design of the main page can be changed only after consulting the manufacturer; we offer a “Customization” program. For more information, please contact your dealer.

General Setup

Network settings of the device: Network parameters, trusted IP address range, temperature units, output states, etc.

Damocles2 2404 GENERAL SETUP

Device

Name	Value
Device Name:	Damocles2 2404

Network Settings

Name	Value
IP Address:	192.168.100.66
Submask:	255.255.255.0
Gateway:	192.168.100.1
Primary DNS:	192.168.100.253
Secondary DNS:	192.168.100.250
HTTP Port:	80 0=dis, def 80
HTTPS Port:	443 0=dis, def 443
TCP Telnet Setup:	99 0=dis, def 99
DHCP Client:	<input checked="" type="checkbox"/>

IPV6

Name	Value
Enable IPv6:	<input type="checkbox"/>
Autoconfig IP parameters:	
Link Local Address:	
IP Address / Prefix length:	
Gateway:	
Primary DNS:	
Secondary DNS:	

Other settings and information

Name	Value
Syslog IP Address:	0.0.0.0
HW Security Protection:	Disabled

Counters

Name	Value
Counters enable:	<input checked="" type="checkbox"/>
All counters reset :	<input type="button" value="Reset"/>

For more information try <http://www.hw-group.com/>

Version: 3.0.8

Device name

- **Name** – assigned to a particular device. This name is shown in all overviews along with the IP address (UDP Config); it is used as the sysname variable in SNMP.

Network Settings

This block configures the main network parameters for Ethernet communication:

- **IP address** – IP address of the unit. After a change, the device needs to be restarted.
- **Submask** – Local network mask. After a change, the device needs to be restarted.
- **Gateway** – Default gateway. After a change, the device needs to be restarted.
- **Primary DNS/Secondary DNS** – Primary and secondary DNS server settings. Gateway needs to be set correctly for correct operation.
- **HTTP port** – Port for communication using the HTTP protocol. Default is **80**.
- **HTTPS port** – Port for communication over the HTTPS protocol. Default is **443**.
- **TCP Telnet Setup** – Port for the terminal telnet setup mode. Default is **99**.
- **DHCP Client** – Activates automatic network configuration using a DHCP server. Enabled by default.

A DNS server is necessary for converting domain names to IP addresses. Without a correctly configured DNS server, the following functions will not work:

- Time sync (SNTP), used in e-mails and SNMP traps to timestamp events
- E-mailing (SMTP)
- Logging of values with timestamps

IPV6

This block groups options for operation in networks that support IPv6.

- **Enable IPv6** – Enables IPv6 support.
- **Autoconfig IP parameters** – Enables automatic network configuration using SLAAC.
- **Link Local Address** – Link address of the device – only visible from the local network.
- **IP Address / Prefix length** – Global (public) IP address and network prefix. Consists of the link address and the network prefix.
- **Gateway** – Default gateway. After a change, the device needs to be restarted.
- **Primary DNS/Secondary DNS** – Primary and secondary DNS server settings. Gateway needs to be set correctly for correct operation.

Other Settings and Information

- **Syslog IP Address** – Syslog server address – only for HW group debugging purposes.
- **HW Security Protection** – A DIP switch that prevents any changes in the device configuration.
 - **Outputs:** Values of outputs can be changed.
 - **Configuration:** No changes are permitted.

The protection status is displayed in the bottom left-hand corner. When the HW Protection is active, any configuration changes, including changes of the output states, are ignored. This mode is useful when connecting Damocles2 to a publicly accessible network.

Note: Any changes must be confirmed by clicking the Apply Changes button. A successful change is indicated by an animation in the status bar next to the Apply changes button.

Counters

Resets the counter states at all device inputs – see Inputs. Resetting the device also resets the counters.

Security

Security settings. Restrictions in individual modes are shown in the following table. Lines indicate the method of accessing the device over IP, columns specify the restrictions resulting from the respective security settings.

	No restrictions (default)	HW protection DIP = On	User Password			IP Access filter		SNMP Communities	
			Read only	Read + Outputs	Read & Write	HTTP	SNMP	Comun1	Comun2
Web index (General)	yes	yes	yes	yes	yes	filtered	-	-	-
Other pages	R/W	R	R	R/W**	R/W	filtered	-	-	-
Values.xml	R	R	R	R	R	filtered	-	-	-
Setup.xml	R/W	R	R	R/W**	R/W	filtered	-	-	-
SNMP get (next)	R	R	-	-	-	-	filtered	R*	R*
SNMP set	W	no	-	-	-	-	filtered	[R*/]W*	[R*/]W*
Modbus/TCP	R/W	R	-	-	-	-	-	-	-
TCP setup	yes	no	no	no	yes	-	-	-	-
UDP config	R/W	R	-	-	-	-	-	-	-
FW update	yes	no	no	no	yes	filtered	-	-	-
M2M outputs	R/W	R/W	R	R/W	R/W	-	-	-	-

* R and/or W must be enabled on the SNMP Setup tab by checking appropriate boxes.
W** Only outputs can be changed, nothing else. Even the output mode cannot be changed.

Note: The "No restrictions" column reflects the default configuration (see also the screenshots). That is, HW protection DIP=Off, no password set, IP Access filter set to 0.0.0.0/0.0.0.0.

IP Access Filter

Allows defining a range of trusted IP addresses that are allowed to access Damocles2 over HTTP and SNMP. The IP range is configured separately for each protocol.

To set up the filter, specify the base IP address and the mask that define the trusted range according to the formula below (AND is bitwise multiplication). Access is granted if the condition is true.

$(IP \text{ trying to access AND Mask Value}) = IP \text{ Address Value}$

IP Filter settings		Access granted from – to	Note
IP address value	Mask value		
192.168.1.2	192.168.1.2	192.168.1.2	Only one IP allowed
192.168.1.87	192.168.1.87	192.168.1.87	Only one IP allowed
192.168.1.0	192.168.1.224	192.168.1.0 – 192.168.1.31	32 allowed addresses
192.168.1.0	192.168.1.0	192.168.1.0 – 192.168.1.255	All 256 addresses 192.168.1.x
192.168.0.2	192.168.254.255	192.168.0.2 and 192.168.1.2	One address but on two networks
192.168.0.0	192.168.252.240	192.168.0.0 – 192.168.0.15 192.168.1.0 – 192.168.1.15 192.168.2.0 – 192.168.2.15 192.168.3.0 – 192.168.3.15	4 × 16 addresses allowed

User Passwords

Two separate user accounts (username and password) can be set up for SNMP and HTTP access.

- Account types:
 - **Read Only** – can only read values and configuration settings.
 - **Read Only + Outputs** – can read values and set outputs, cannot change configuration settings (not even input names).
 - **Read & Write** – can perform any changes.
- After setting up a username and a password, you will be asked to log in every time you try to open the Web interface.
- Passwords also apply to access to /values.xml and /setup.xml – see the table.

In case of “Read Only” user for HTTP access, you will no longer be able to change configuration settings in the web interface.

What to do if you forget your password

- Restore the factory-default configuration of the device by one of the following methods:
 - Use the **UDP Config** utility (must run on the same network segment).
 - Right-click the line corresponding to the device and select “Load defaults” from the pop-up menu.
 - Use the **DIP Load defaults** feature.
 - Toggle DIP1 several times during the first 5 seconds after powering up the device.

HTTPS Server Certificate files

Used to manage certificates needed for the HTTPS server. Allows you to upload or delete a public key, a private key, or a certificate of the certificate authority (CA) that has issued the public key certificate.

SNMP

The SNMP Setup tab allows you to configure the settings for communication with the device using the SNMP protocol. The page content is slightly different for SNMPV1 and SNMPV3. See below.

SNMPv1

The screenshot shows the web interface for a Damocles2 2404 device, specifically the SNMP configuration page. The interface is blue and white. On the left is a navigation menu with options: General, General setup, Security, **SNMP** (selected), Modbus, Email, GSM, Log & Time, Portal, MQTT, Inputs, Outputs, Virtual Outputs, System, and a version indicator 'Version: 3.0.8'. Below the menu is an 'Apply Changes' button.

The main content area is titled 'Damocles2 2404' and 'SNMP'. It is divided into several sections:

- General SNMP Settings:** A table with columns 'Name' and 'Value'.

Name	Value
SNMP Port:	161
SNMP Port Listener:	162
SNMP Version:	1
- SNMP Access:** A table with columns 'Community', 'Read', and 'Write'.

Community	Read	Write
Public	<input checked="" type="checkbox"/>	<input type="checkbox"/>
Private	<input checked="" type="checkbox"/>	<input checked="" type="checkbox"/>
- SNMP Trap Destinations:** A table with columns 'Destination', 'Community', 'IP Address', and 'Port'.

Destination	Community	IP Address	Port
A.	Public	192.168.1.39	162
B.	---- Disabled ----		
C.	---- Disabled ----		
D.	---- Disabled ----		
E.	---- Disabled ----		
- SNMP Communities:** A table with a 'Community' column.

Community
Public
Private
- MIB II System Group:** A table with columns 'Name' and 'Value'.

Name	Value
SysContact:	support@HWgroup.cz
SysName:	Damocles2 2404
SysLocation:	

At the bottom right, there is a link: 'For more information try <http://www.hw-group.com/>'.

General SNMP Settings

- **SNMP port** – Communication port to use for the SNMP protocol **[161]**.
- **SNMP Port Listener** – Port for receiving SNMP traps from Poseidon and Damocles devices in Box2Box communication mode **[162]**.
- **SNMP Version** – SNMP protocol version setting **[1]**.
 - SNMPV3 is recommended for secure communication – enable it here.

SNMP Access

Defines names and access rights for groups of users that can work with the Damocles device.

- **Community** – Textual name of the authorized group (usually **Public** and **Private**).
 - **Read** – The community is authorized to read variables over SNMP.
 - **Write** – The community is authorized to write values to variables over SNMP.

SNMP Trap Destination

Destinations for sending SNMP Traps.

- **Community** – Textual name of the group for the SNMP trap being sent.
- **IP address** – Destination address where the SNMP traps are sent.
- **Port** – Destination port where the SNMP traps are sent.

SNMP Communities

- **Community** – Textual name of the security group.

MIB II System Group

User-defined data in the standard SNMP header.

- **SysContact** – Contact information of the system administrator, e.g. an e-mail address.
- **SysName** – Same as the device name.
- **SysLocation** – Location of the unit, e.g. “IT room, floor 2”.

Note: Any changes must be confirmed by clicking the *Apply Changes* button. A successful change is indicated by an animation in the status bar next to the *Apply changes* button.

SNMPv3

When the SNMP version is changed, the SNMP parameter interface also changes.

Damocles2 2404 SNMP

General SNMP Settings

Name	Value
SNMP Port:	161
SNMP Port Listener:	162
SNMP Version:	3

SNMP Access

User name	Read	Write
Public	<input checked="" type="checkbox"/>	<input type="checkbox"/>
Private	<input checked="" type="checkbox"/>	<input checked="" type="checkbox"/>

SNMP Trap Destinations

Destination	User name	IP Address	Port
A.	Public	192.168.1.39	162
B.	---- Disabled ----		
C.	---- Disabled ----		
D.	---- Disabled ----		
E.	---- Disabled ----		

SNMP Users

User name	Auth. Type	Auth. Password	Privacy Type	Privacy Password
Public	MDS	Pass1	DES	Pass2
Private	SHA	Pass3	AES	Pass4
	None		None	
	None		None	
	None		None	

MIB II System Group

Name	Value
SysContact:	support@HWgroup.cz
SysName:	Damocles2 2404
SysLocation:	

For more information try <http://www.hw-group.com/>

Version: 3.0.8

Apply Changes

General SNMP Settings

- **SNMP port** – Communication port to use for the SNMP protocol **[161]**.
- **SNMP Port Listener** – Port for receiving SNMP traps from Poseidon and Damocles devices in Box2Box communication mode **[162]**.
- **SNMP Version** – SNMP protocol version setting **[3]**.

SNMP Access

Defines names and access rights for groups of users that can work with the Damocles device.

- **User name** – Textual name of the authorized group (by default **Public** and **Private**).
 - **Read** – The community is authorized to read variables over SNMP.
 - **Write** – The community is authorized to write values to variables over SNMP.

SNMP Trap Destination

Destinations for sending SNMP Traps.

- **User name** – Textual name of the group for the SNMP trap being sent.
- **IP address** – Destination address where the SNMP traps are sent.
- **Port** – Destination port where the SNMP traps are sent.
- **Enable** – SNMP traps are sent to this destination.

SNMP Users

Usernames and passwords for SNMPv3 communication.

- **User name** – User name.
- **Auth. Type** – Cipher type for user authentication. Available options are MD5 and SHA.
- **Auth Password** – Password for user authentication.
- **Privacy Type** – Cipher type for encrypting the communication. Available options are DES and AES.
- **Privacy Password** – Password (key) for encrypting the communication.

MIB II System Group

User-defined data in the standard SNMP header.

- **SysContact** – Contact information of the system administrator, e.g. an E-mail address.
- **SysName** – Same as the device name.
- **SysLocation** – Location of the unit, e.g. “IT room, floor 2”.

Note: Any changes must be confirmed by clicking the *Apply Changes* button. A successful change is indicated by an animation in the status bar next to the *Apply Changes* button.

Modbus

Note: The Modbus/TCP protocol is not secured in any way. We do not recommend using it outside of an isolated network. For basic security, it can be combined with the IP address filter.

E-mail

- **SMTP Server** – Host name or IP address of the SMTP server.
- **SMTP Port** – Port for communication with the SMTP server (**25** by default).
- **E-mail Sender Address** – E-mail address that will be shown in the “From” field.
- **Authentication** – Enables username/password authentication if the SMTP server requires it.
 - **Secure TLS mode** – Activates SSL/TLS authentication (e.g. for gmail).
 - **Name** – Username for authentication with the SMTP server.
 - **Password** – Password for authentication with the SMTP server.
- **E-mail Subject Text** – Subject of the e-mails sent, followed by the default e-mail text (see e-mail format).
- **Alarm E-mail Recipient** – E-mail address of the main recipient (To).
- **Alarm E-mail Copy** – E-mail address of the carbon-copy recipient (Cc).
- **Periodic Log Recipient** – E-mail address of the recipient for periodically e-mailed logs.
- **Send Test Email** button – sends a test e-mail.

Send Test Email

Tip: It is not always necessary to configure a SMTP Server in order to send e-mails. Damocles2 can work as SMTP server itself and deliver the e-mails directly to the user's mailbox.

However, always test this mode in your particular environment – the e-mails sent in this mode are often blocked by various spam filters due to missing reverse MX records.

Damocles2 can only send e-mails, it cannot receive them.

E-mail is sent upon every alarm activation and deactivation.

Sending a test e-mail

Multiple systems need to be configured correctly in order to send e-mails from the device successfully. Therefore, it is advisable to double-check the following parameters:

- **Gateway** in the network settings.
- **DNS server** in the network settings.
- **SMTP server** and port.
- **Authentication** turned on, correct **name** and **password**.
- **Spam filter** of your mailbox turned off.

Received e-mail example:

```
DATE TIME Device_NAME Device_IP
01.09.2016 13:42:19 Damocles2 1208 192.168.100.55
```

Email initiated: Test

```
ID SENSOR_Name VALUE UNIT Safe_RANGE ALARM
```

ALARM state:

```
1 Binary 1 ON if ON
```

Sensors list:

```
1 Binary 1 OFF Disabled
2 Binary 2 OFF Disabled
3 Binary 3 OFF Disabled
4 Binary 4 OFF Disabled
5 Binary 5 OFF Disabled
6 Binary 6 OFF Disabled
7 Binary 7 OFF Disabled
8 Binary 8 OFF Disabled
9 Binary 9 OFF Disabled
10 Binary 10 OFF Disabled
11 Binary 11 OFF Disabled
12 Binary 12 OFF Disabled
123 Comm Monitor 1 OFF Disabled
151 BinOut 1 OFF Manual
152 BinOut 2 OFF Manual
153 BinOut 3 OFF Manual
154 BinOut 4 OFF Manual
155 BinOut 5 OFF Manual
156 BinOut 6 OFF Manual
157 BinOut 7 OFF Manual
158 BinOut 8 OFF Manual
1151 VirtBinOut 1 OFF Manual
1152 VirtBinOut 2 OFF Manual
1153 VirtBinOut 3 OFF Manual
1154 VirtBinOut 4 OFF Manual
1155 VirtBinOut 5 OFF Manual
1156 VirtBinOut 6 OFF Manual
1157 VirtBinOut 7 OFF Manual
1158 VirtBinOut 8 OFF Manual
```

```
Damocles2 1208: http://192.168.100.55 00:0A:59:04:40:E0
```

Tip: For detailed description of the e-mail format, see the "Using Damocles2 units in your programs" section: <http://hw-group.us/cs/podpora/kba004-pouziti-damocles2-ve-vasich-programech>

GSM SMS Interface

Sekce Serial Port Settings

Port Function – sets the serial port function (only for models with a serial port and the netGSM server side feature). 3 options are available:

- **Disabled** – Serial port is off. Only if no modem is connected and the device works as the client side.
- **GSM modem** – A GSM modem is connected, and Damocles2 also acts as a netGSM server.

Remote SMS gateway

Configures the IP address, HTTP port and path to the service for sending SMS requests.

For Damocles2, the path is always service.xml.

GSM SMS interface

Configures the parameters for sending text messages.

- **GSM Function** – Selects whether SMS are sent through a local modem (only available if the serial port is in GSM Modem mode).
- **SMS+Ring when Alarm** – Enables sending a SMS and then dialing the number.
- **RS-232 GSM module** (only for Damocles2 2404 with a RS-232 modem connected) – Indicates if the GSM modem is ready.
 - **Not Enabled** – Modem inactive. Shown after changing RS-232 port configuration but before saving it.
 - **Not Found** – Damocles2 is configured for a locally-connected GSM modem but the modem was not found.
 - **Waiting for modem** – Looking for the modem.
 - **Initializing** – The modem is being initialized.
 - **Ready** – The modem is ready.
- **SMS center Number** (only for Damocles2 2404 with a RS-232 modem connected) – Provider's SMS center number, as read from the SIM card. If the number has not been read, it is not possible to send SMS.

Sekce GSM SMS recipients

Configures the numbers of SMS recipients, regardless of the mode of operation (local/remote modem).

- **Send test SMS** – Send a test SMS to all configured numbers.
- **RingOut Test** – Dials all configured numbers.

SMS example:

Alarm ACTIVATED, Damocles2 2404, Binary 10, ON

- Device name: **Damocles2 2404**
- Inputs/outputs in alarm:
 - Binary 10 = input name
 - ON = alarm state, OFF = idle state

Tip: For detailed description of the SMS format, see the SMS interface description in the "Using Damocles2 units in your programs" section.

<http://hw-group.us/cs/podpora/kba004-pouziti-damocles2-ve-vasich-programech>.

Note: Any changes must be confirmed by clicking the Apply Changes button. A successful change is indicated by an animation in the status bar next to the Apply changes button.

GSM modem (local or remote)

The screenshot shows the web interface for a Damocles2 2404 unit. The left sidebar contains a menu with options: General, General setup, Security, SNMP, Modbus, Email, **GSM** (highlighted), Log & Time, Portal, MQTT, Inputs, Outputs, Virtual Outputs, and System. The main content area is titled "Damocles2 2404" and "GSM". It is divided into three sections: "Serial Port Settings", "Remote SMS gateway", and "GSM SMS Interface".

- Serial Port Settings:** A table with columns "Name" and "Value". The "Port Function" is set to "Disabled".
- Remote SMS gateway:** A table with columns "Name" and "Value". Fields include: "Enable:" (checkbox), "IP Address or DNS Name:" (192.168.1.36), "Link/Path:" (service.xml), "Port:" (80), "Username:" (empty), and "Password:" (empty).
- GSM SMS Interface:** A table with columns "Name" and "Value". Fields include: "GSM Function:" (Remote) and "SMS + Ring When Alarm:" (checkbox).
- GSM SMS Recipients:** A table with columns "Name", "Value", and "Test". It lists five "Alarm SMS Recipient" entries with input fields for their values. There are "Send Test SMS" and "Ringout Test" buttons.

At the bottom left, there is a "Version: 3.0.8" label and an "Apply Changes" button. At the bottom right, there is a link: "For more information try <http://www.hw-group.com/>".

Text messages (SMS) can be sent in two ways:

A) Remote GSM modem – Damocles2 does not have its own GSM modem. "Serial Port Settings" is set to "Disabled". To send a SMS, a GSM modem connected to another Damocles2 unit or the "HWg-SMS GWx" product is used. The remote GSM modem must be accessible over the network, via an A address, by default at port 80 under "service.xml".

B) Local GSM modem (only for Damocles2 2404 with a RS-232 modem connected) – A GSM modem is connected to the RS-232 interface of Damocles2. The modem is powered from its own adapter or from the 12V terminals. An activated SIM is inserted in the modem, PIN is disabled. SMS Center should be retrieved from the SIM after start-up.

SOAP protocol is used for communication. If the connection is not established or is refused, Damocles2 tries to send the SMS again.

The throughput of the remote GSM modem is limited to 5 SMS per minute for Damocles2 units and about 20 SMS per minute for "SMS GW".

Log & Time

Date, time, and data logger configuration.

Damocles2 2404 LOG AND TIME

Date and Time

Name	Value	Description
Current Date:	18.10.2016	[dd.mm.yyyy]
Current Time:	16:20:05	[24 hour format]

Time Synchronization

Name	Value	Description
SNTP Server:	time.nist.gov	[IP Address or DNS Name]
Time zone:	+1hour : 0 min	
Interval:	10 hour	Sync period: 1h/10h/24h

Synchronize Time

Device Logger Settings

Name	Value	Description
Log period:	300 [s]	
Logfile capacity:	82days, 2hours and 2minutes	
Report Log Period:	1 [h]	
Erase log after e-mail:	<input checked="" type="checkbox"/>	

Open log File Clear log File

Version: 3.0.8

Apply Changes

For more information try <http://www.hw-group.com/>

Date and Time

Current date and time settings.

- **Current Date** – Date in the [dd.mm.yyyy] format, for example: **31. 12. 2017**.
- **Current Time** – Current time in the 24-hour [hh:mm:ss] format, for example: **17:38:55**. The time updates automatically while the browser window is open. It is only saved when the “**Apply Changes**” button is clicked.

Time Synchronization

SNTP server settings for time synchronization. If the time is not set (the date 1. 1. 1970 is displayed), the device attempts to synchronize the time approximately once per hour until successful.

- **SNTP Server** – IP address or host name of the SNTP server to synchronize the time with.
- **Time zone** – Set the offset of your time zone against the SNTP server time. SNTP servers use UTC time, which is nearly equivalent to GMT (London time). Hence, for Paris, Berlin, Prague, and other locations within the same time zone, set +1 hour.
- **Interval** – Specifies how often the time is synchronized with the time server. A shorter interval can achieve higher time accuracy, and works around certain managed switches that disconnect ports when there is no active communication.

Note: The clock does not run when the device is powered off. The device contains no battery. After a power failure, the time will be synchronized with the SNTP server.

Data Logger Settings

Configuration parameters for logging values to a circular buffer within the internal flash memory. When the buffer is full, the oldest values are overwritten with the newest ones.

- **Log Period** – Period of logging into the logfile for all values.
- **Logfile capacity XXX** – The capacity estimate is given in days, hours and minutes. Damocles2 calculates the capacity based on the number of DI inputs.

Caution: When the circular buffer is full, the remaining capacity shown will be zero. Clear the buffer to find out the total capacity.

- **Report Log Period** – Period for e-mailing the log.
- **Erase log after E-mail** – The log is cleared after it is e-mailed. This reduces attachment size and can speed up data transfer.
- **Open log File** button – Stores the current logfile to disk by calling the external **/spilog.txt** file.
- **Clear log File** button – Clears all values from the logfile by calling the external **/spilog.del** file.

Note: Any changes must be confirmed by clicking the **Apply Changes** button. A successful change is indicated by an animation in the status bar next to the **Apply changes** button.

Damocles2 2404 PORTAL

Portal Message

Name	Value
Portal Enable:	<input type="checkbox"/>
Server Address:	www.sensdesk.com/portal.php
IP Port:	80 Default: 80
User Name:	vitolmr
Password:	*****
Current Push Timer:	0
Current Log Timer:	0
Current Check Timer:	0
Cur. Autopush Block Timer:	0
Retransmit number:	1

Manual Push:

Dry Contact Inputs autopush config

Name	ID	Current Value	Autopush
Binary 1	1	0(Off)	<input type="checkbox"/>
Binary 2	2	0(Off)	<input type="checkbox"/>
Binary 3	3	0(Off)	<input type="checkbox"/>
Binary 4	4	0(Off)	<input type="checkbox"/>
Binary 5	5	0(Off)	<input type="checkbox"/>
Binary 6	6	0(Off)	<input type="checkbox"/>
Binary 7	7	0(Off)	<input type="checkbox"/>
Binary 8	8	0(Off)	<input type="checkbox"/>
Binary 9	9	0(Off)	<input type="checkbox"/>
Binary 10	10	0(Off)	<input type="checkbox"/>
Binary 11	11	0(Off)	<input type="checkbox"/>
Binary 12	12	0(Off)	<input type="checkbox"/>
Binary 13	13	0(Closed)	<input type="checkbox"/>
Binary 14	14	0(Closed)	<input type="checkbox"/>
Binary 15	15	0(Closed)	<input type="checkbox"/>
Binary 16	16	0(Closed)	<input type="checkbox"/>
Binary 17	17	0(Closed)	<input type="checkbox"/>
Binary 18	18	0(Closed)	<input type="checkbox"/>
Binary 19	19	0(Closed)	<input type="checkbox"/>
Binary 20	20	0(Closed)	<input type="checkbox"/>
Binary 21	21	0(Closed)	<input type="checkbox"/>
Binary 22	22	0(Closed)	<input type="checkbox"/>
Binary 23	23	0(Closed)	<input type="checkbox"/>
Binary 24	24	0(Closed)	<input type="checkbox"/>
Comm Monitor 1	123	0(Off)	<input type="checkbox"/>

Version: 3.0.8

For more information try <http://www.hw-group.com/>

Portal Message section

Information from the portal, such as links to graphs. Depends on the portal type.

Portal

- **Portal enable** – Turns this feature on or off.
- **Server address** – Complete URL of the remote server.
- **IP Port** – Port where the portal listens.
- **User Name** – Username for assigning to a user. You will receive it from your portal administrator.
- **Password** – Password for assigning to a user. You will receive it from your portal administrator.
- **Current Push Timer** – Indicates the remaining time before the next standard data upload.
- **Current Log Timer** – Indicates the remaining time before the next caching of data.
- **Current Check Timer** – Indicates the time remaining until the next Check Push (to check if an output state change is requested).
- **Current Autopush Block Timer** – Indicates the delay from one AutoPush upload to the next. The period is configured from the portal.
- **Retransmit number** – Number of retransmissions if a Push fails.
- **Manual Push** – Button for immediate manual upload of data to the portal.

AutoPush configuration

Damocles2 connects to the portal immediately and notifies a change of an input state (at most 30s from the last change). This configuration only applies to the communication between Damocles2 and the online portal. Local alarm values are configured in the portal.

For portal connection, check:

1. Correct **Gateway IP** address
2. **DNS server** in network settings
3. Correct **Server Address** of the portal

Configures the communication with the portal using the HWg-Push protocol. Damocles2 is the active side and establishes communication periodically and upon every DI change.

Connection parameters for the www.SensDesk.com portal are pre-filled.

MQTT

Used to connect Damocles2 to an IoT network using the MQTT protocol.

Damocles2 2404 MQTT

MQTT Settings

Name	Value	Description
MQTT Enable:	<input type="checkbox"/>	Enable/Disable MQTT Client services.
Server:	iot.eclipse.org	[IP Address or DNS Name]
Port:	1883	Default 1883 or 8883 for SSL.
Username:		
Password:		
Secure SSL mode:	<input type="checkbox"/>	
Client ID:		
Publish Period:	60	
Topic Prefix Name:		

Sensors Topic

Name	ID	Publis	Topic Name = value
Binary 1	1	<input type="checkbox"/>	1/Value = 0 1/State = 0 1/Counter = 0
Binary 2	2	<input type="checkbox"/>	2/Value = 0 2/State = 0 2/Counter = 0
Binary 3	3	<input type="checkbox"/>	3/Value = 0 3/State = 0 3/Counter = 0
Binary 4	4	<input type="checkbox"/>	4/Value = 0 4/State = 0 4/Counter = 0
Binary 5	5	<input type="checkbox"/>	5/Value = 0 5/State = 0 5/Counter = 0
Binary 6	6	<input type="checkbox"/>	6/Value = 0 6/State = 0 6/Counter = 0
Binary 7	7	<input type="checkbox"/>	7/Value = 0 7/State = 0 7/Counter = 0
Binary 8	8	<input type="checkbox"/>	8/Value = 0 8/State = 0 8/Counter = 0
Binary 9	9	<input type="checkbox"/>	9/Value = 0 9/State = 0 9/Counter = 0
Binary 10	10	<input type="checkbox"/>	10/Value = 0 10/State = 0 10/Counter = 0
Binary 11	11	<input type="checkbox"/>	11/Value = 0 11/State = 0 11/Counter = 0
Binary 12	12	<input type="checkbox"/>	12/Value = 0 12/State = 0 12/Counter = 0
Binary 13	13	<input type="checkbox"/>	13/Value = 0 13/State = 0 13/Counter = 0
Binary 14	14	<input type="checkbox"/>	14/Value = 0 14/State = 0 14/Counter = 0
Binary 15	15	<input type="checkbox"/>	15/Value = 0 15/State = 0 15/Counter = 0

Inputs Topic

Name	ID	Publis	Topic Name = value
Binary 1	1	<input type="checkbox"/>	1/Value = 0 1/State = 0 1/Counter = 0
Binary 2	2	<input type="checkbox"/>	2/Value = 0 2/State = 0 2/Counter = 0
Binary 3	3	<input type="checkbox"/>	3/Value = 0 3/State = 0 3/Counter = 0
Binary 4	4	<input type="checkbox"/>	4/Value = 0 4/State = 0 4/Counter = 0
Binary 5	5	<input type="checkbox"/>	5/Value = 0 5/State = 0 5/Counter = 0
Binary 6	6	<input type="checkbox"/>	6/Value = 0 6/State = 0 6/Counter = 0
Binary 7	7	<input type="checkbox"/>	7/Value = 0 7/State = 0 7/Counter = 0
Binary 8	8	<input type="checkbox"/>	8/Value = 0 8/State = 0 8/Counter = 0
Binary 9	9	<input type="checkbox"/>	9/Value = 0 9/State = 0 9/Counter = 0
Binary 10	10	<input type="checkbox"/>	10/Value = 0 10/State = 0 10/Counter = 0
Binary 11	11	<input type="checkbox"/>	11/Value = 0 11/State = 0 11/Counter = 0
Binary 12	12	<input type="checkbox"/>	12/Value = 0 12/State = 0 12/Counter = 0
Binary 13	13	<input type="checkbox"/>	13/Value = 0 13/State = 0 13/Counter = 0
Binary 14	14	<input type="checkbox"/>	14/Value = 0 14/State = 0 14/Counter = 0
Binary 15	15	<input type="checkbox"/>	15/Value = 0 15/State = 0 15/Counter = 0

Version: 3.0.8

Apply Changes

Outputs Topic

Name	ID	Publis	Topic Name = value
BinOut 1	151	<input type="checkbox"/>	151/Value = 0
BinOut 2	152	<input type="checkbox"/>	152/Value = 0
BinOut 3	153	<input type="checkbox"/>	153/Value = 0
BinOut 4	154	<input type="checkbox"/>	154/Value = 0
VirtBinOut 1	1151	<input type="checkbox"/>	1151/Value = 0
VirtBinOut 2	1152	<input type="checkbox"/>	1152/Value = 0
VirtBinOut 3	1153	<input type="checkbox"/>	1153/Value = 0
VirtBinOut 4	1154	<input type="checkbox"/>	1154/Value = 0
VirtBinOut 5	1155	<input type="checkbox"/>	1155/Value = 0
VirtBinOut 6	1156	<input type="checkbox"/>	1156/Value = 0
VirtBinOut 7	1157	<input type="checkbox"/>	1157/Value = 0
VirtBinOut 8	1158	<input type="checkbox"/>	1158/Value = 0

For more information try <http://www.hw-group.com/>

MQTT Settings section

- **MQTT Enable** – Enables or disables data transfer using the MQTT protocol.
- **Server** – IP address or domain name of the MQTT broker server.
- **Port** – TCP port where the MQTT broker listens (default is 1883, or 8883 for SSL).
- **Username** – User name for logging in to the MQTT broker.
- **Password** – Password for logging in to the MQTT broker.
- **Secure SSL mode** – Enables or disables SSL support when communicating with the MQTT broker.
- **Client ID** – Device ID in the MQTT network.
- **Publish Period** – Frequency of sending data to the MQTT broker.
- **Topic Prefix Name** – MQTT Topic (address) prefix.

Inputs Topic

- **Name** – Corresponds to the input name at the Inputs tab.
- **ID** – Corresponds to the input ID at the Inputs tab.
- **Publish** – Enables or disables the sending of information about a particular input.
- **Topic Name = value** – Complete Topic after the prefix:
 - **x/Value** – Current input value.
 - **x/State** – Current input status.
 - **x/Counter** – Current counter status.

Outputs Topic

- **Name** – Corresponds to the output name at the Outputs tab.
- **ID** – Corresponds to the output ID at the Outputs tab.
- **Publish** – Enables or disables the sending of information about a particular output.
- **Topic Name = value** – complete Topic after the prefix:
 - **x/Value** – current input value.

For more information about MQTT and its use, see ANXXX at the [HW-group.com](http://www.hw-group.com) website.

Digital Inputs (DI)

Parameters for DI (Dry Contact Inputs). Damocles inputs feature pulse counters; this can be used for example to read energy consumption meters with a pulse output (SO). Counters are incremented whenever the input is closed. The pulse must be longer than 20 ms to be registered.

Counters are 32 bit (maximum value 4 294 967 295). Values are retained in memory even when the power is off. They can be reset (for the entire device) at the General Setup tab.

Name	ID	Current Value	Alarm State	Delay[s]	SNMP Trap	Email	SMS
Binary 1	1	0(Off)	Active if on	0	<input checked="" type="checkbox"/>	<input checked="" type="checkbox"/>	<input checked="" type="checkbox"/>
Binary 2	2	0(Off)	Disabled	0	<input type="checkbox"/>	<input type="checkbox"/>	<input type="checkbox"/>
Binary 3	3	0(Off)	Disabled	0	<input type="checkbox"/>	<input type="checkbox"/>	<input type="checkbox"/>
Binary 4	4	0(Off)	Disabled	0	<input type="checkbox"/>	<input type="checkbox"/>	<input type="checkbox"/>
Binary 5	5	0(Off)	Disabled	0	<input type="checkbox"/>	<input type="checkbox"/>	<input type="checkbox"/>
Binary 6	6	0(Off)	Disabled	0	<input type="checkbox"/>	<input type="checkbox"/>	<input type="checkbox"/>
Binary 7	7	0(Off)	Disabled	0	<input type="checkbox"/>	<input type="checkbox"/>	<input type="checkbox"/>
Binary 8	8	0(Off)	Disabled	0	<input type="checkbox"/>	<input type="checkbox"/>	<input type="checkbox"/>
Binary 9	9	0(Off)	Disabled	0	<input type="checkbox"/>	<input type="checkbox"/>	<input type="checkbox"/>
Binary 10	10	0(Off)	Disabled	0	<input type="checkbox"/>	<input type="checkbox"/>	<input type="checkbox"/>
Binary 11	11	0(Off)	Disabled	0	<input type="checkbox"/>	<input type="checkbox"/>	<input type="checkbox"/>
Binary 12	12	0(Off)	Disabled	0	<input type="checkbox"/>	<input type="checkbox"/>	<input type="checkbox"/>
Binary 13	13	0(Off)	Disabled	0	<input type="checkbox"/>	<input type="checkbox"/>	<input type="checkbox"/>
Binary 14	14	0(Off)	Disabled	0	<input type="checkbox"/>	<input type="checkbox"/>	<input type="checkbox"/>
Binary 15	15	0(Off)	Disabled	0	<input type="checkbox"/>	<input type="checkbox"/>	<input type="checkbox"/>
Binary 16	16	0(Off)	Disabled	0	<input type="checkbox"/>	<input type="checkbox"/>	<input type="checkbox"/>
Binary 17	17	0(Off)	Disabled	0	<input type="checkbox"/>	<input type="checkbox"/>	<input type="checkbox"/>
Binary 18	18	0(Off)	Disabled	0	<input type="checkbox"/>	<input type="checkbox"/>	<input type="checkbox"/>
Binary 19	19	0(Off)	Disabled	0	<input type="checkbox"/>	<input type="checkbox"/>	<input type="checkbox"/>
Binary 20	20	0(Off)	Disabled	0	<input type="checkbox"/>	<input type="checkbox"/>	<input type="checkbox"/>
Binary 21	21	0(Off)	Disabled	0	<input type="checkbox"/>	<input type="checkbox"/>	<input type="checkbox"/>
Binary 22	22	0(Off)	Disabled	0	<input type="checkbox"/>	<input type="checkbox"/>	<input type="checkbox"/>
Binary 23	23	0(Off)	Disabled	0	<input type="checkbox"/>	<input type="checkbox"/>	<input type="checkbox"/>
Binary 24	24	0(Off)	Disabled	0	<input type="checkbox"/>	<input type="checkbox"/>	<input type="checkbox"/>
Comm Monitor 1	123	0(Off)	Disabled	0	<input type="checkbox"/>	<input type="checkbox"/>	<input type="checkbox"/>

- **Name** – Name of the input, up to 12 chars (e.g. “left door”, “smoke room 1”).
- **ID** – Unique ID of the input variable within the device [1 – 32].
- **Current Value** – Current state of the input (“0 (Off)”/“1 (On)”).
- **Alarm State** – Alarm state definition for each input.
 - **Active if On** – Alarm is active whenever the input is in 1 (On).
 - **Active if Off** – Alarm is active whenever the input is in 0 (Off).
 - **Disabled** – Input has no alarm state defined.
- **Delay [s]** – Delays the sending of information about alarm beginning and alarm end.
- **Out of Safe Range** – Response to the Alarm state activation/deactivation for dry contact inputs.
- **SNMP Trap** – Enables sending a SNMP trap upon alarm activation/deactivation.
- **E-mail** – Enables sending an e-mail upon alarm activation/deactivation.
- **SMS** – Enables sending a SMS upon alarm activation/deactivation.

Note: SMS (text messages) are sent through a GSM modem connected directly to the Damocles2 unit via the RS-232 interface (see the list of Damocles2 models), or via a remote HWg-SMS-GW3.

The Alarm state for each DI is only active when assigned to an action (sending an e-mail, SMS or SNMP Trap). Nothing checked = no active alarm for the DI input (yellow status in the table at the home page). It is recommended to activate SNMP Trap to notify alarms.

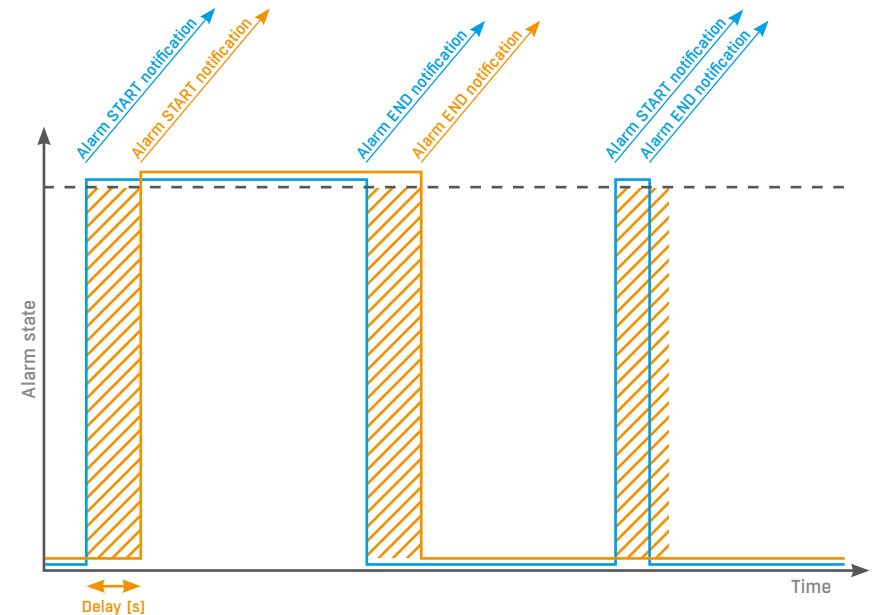

Alarm status notification based on a Delay value:

- **Blue:** Delay = 0
- **Yellow:** Delay is set

Digital Outputs (DO)

Controls the outputs and configures their modes.

ID	Current Value	Basic parameters	Output Control
151	1(On)	Name: BinOut 1 ON (Closed) Name: On OFF (Open) Name: Off Pulse Timer: 0 Sec	<input type="radio"/> Manual <input checked="" type="radio"/> LocalCondition: On if value equal to Trigger Trigger Value: 0.0 Dependent on: Binary 2(2)
152	0(Off)	Name: BinOut 2 ON (Closed) Name: On OFF (Open) Name: Off Pulse Timer: 0 Sec	<input type="radio"/> Manual <input checked="" type="radio"/> LocalCondition Change to On
153	0(Off)	Name: BinOut 3 ON (Closed) Name: On OFF (Open) Name: Off Pulse Timer: 3 Sec	<input type="radio"/> Manual <input checked="" type="radio"/> LocalCondition: On if any alarm
154	0(Off)	Name: BinOut 4 ON (Closed) Name: On OFF (Open) Name: Off Pulse Timer: 0 Sec	<input type="radio"/> Manual <input checked="" type="radio"/> LocalCondition Change to On
1151	0(Off)	Name: VirtBinOut 1 ON (Closed) Name: On OFF (Open) Name: Off Pulse Timer: 5 Sec	<input type="radio"/> Manual <input checked="" type="radio"/> LocalCondition: On if alarm on Dependent on: Binary 19(19)

Basic parameters

- **ID** – Unique ID of the output within the device [151 – 215].
- **Current Value** – Current state of the input („0 (Off)” / „1 (On)”).
- **Name** – Name of the output, up to 12 chars (e.g. “top fan”, “Door rack 4”).
- **ON (Closed) Name** – Name of the “1 (On)” state – e.g. closed, flooded, activated etc.
- **OFF (Open) Name** – Name of the “0 (Off)” state – e.g. open, inactive etc.
- **Pulse timer** – Activates the input (switches to 1 (On) state) only for the defined period. To reverse the function, use the NO/NC relay output. When Pulse Timer = 0, the pulse function is disabled (default).

The pulse also applies to the local condition. The pulse width applies from the beginning of the local condition (safe value exceeded). There is only one pulse per satisfaction of the condition.

Output Control

- **Manual** – Output controlled over the web or M2M protocols (XML, SNMP..).
 - **Change to On/Off** – Change output state (after confirming with Apply Changes).
- **Local Condition** – Output is controlled using a condition and a sensor. The output state is read-only for M2M protocols (output cannot be controlled).
The control is linked to the Target Value, hysteresis is used (IDLE Range) as configured for the sensor.
 - **On if any alarm** – The output is closed if at least one of the inputs or sensors is in alarm.
Caution: This condition also takes into account the DELAY and HYSTERESIS settings for individual active sensors and inputs.
 - **On if alarm on** – The output is closed whenever there is an Alarm at the selected sensor (input).
 - **On if value equal to Trigger** – The output is closed if the value matches the Target Value setting.
 - **On if value higher than Trigger** – The output is closed if the Current Value is greater than the Target Value setting.
 - **On if value Lower than Trigger** – The output is closed if the Current Value is less than the Target Value setting.
- **Trigger Value** – Trigger threshold for the condition (e.g. output is activated if the value is higher than the **Trigger Value**).
- **Dependent On** – Selection of a sensor to which the condition applies.

Virtual Outputs (VDO)

Virtual Outputs allow the use of outputs of other Poseidon2 or Damocles2 units (Box2Box). The communication uses the TCP protocol and updates take place every 60 seconds. For details, see ANXX.

Damocles2 2404 VIRTUAL OUTPUTS

Virtual Digital Outputs (VDO)

ID	Virtual Type	Basic parameters
1151	Network Output	Name: VirtBinOut 1 Remote device address: 192.168.100.63 Port: 80 Remote port ID: 151 Username: Password: Name: VirtBinOut 2 Remote device address: Port: 80 Remote port ID: 0 Username: Password: Name: VirtBinOut 3 Remote device address: Port: 80 Remote port ID: 0 Username: Password: Name: VirtBinOut 4 Remote device address: Port: 80 Remote port ID: 0 Username: Password: Name: VirtBinOut 5 Remote device address: Port: 80 Remote port ID: 0 Username: Password: For more information try http://www.hw-group.com/

- **ID** – Unique ID of the output within the device [1151 – 1158].
- **Virtual Type** – Enables the virtual output functions.
- **Name** – Name of the output, up to 12 chars (e.g. “top fan”, “Door rack 4”).
- **Remote device address** – IP address of the remote side where the output is controlled.
- **Port** – TCP port where the remote side listens.
- **Remote port ID** – Output ID at the remote side. Corresponds to the ID at the Outputs tab at the remote side.
- **Username/Password** – If the remote side uses SW protection against unauthorized use, enter the *Read & Write* or the *Read & Outputs* password.

System

Damocles2 2404 SYSTEM

Communication Monitor

Name	Value	Description
Modbus:	<input type="checkbox"/>	Monitors communication with a device based on all selected protocols. Virtual Input "Comm Monitor 1(123)" sets to 0 in case there was any traffic using all selected protocols within the defined time.
XML/HTTP:	<input type="checkbox"/>	
SNMP:	<input type="checkbox"/>	
Time:	0 [s]	

Configuration

Name	Value	Description
Load Configuration:	Procházet...	Soubor nevybrán. <input type="button" value="Upload"/>
Save Configuration:		<input type="button" value="Download"/>

System

Name	Value	Description
Product Name:	Damocles2 model 2404	
Serial Number:	6006490016	
MAC Address:	00:0A:59:04:41:04	
Build:	1810	
Compiled time:	Oct 18 2016, 15:51:36	
Uptime:	0days,0hours, 31minutes	<input type="button" value="Restart Device"/>
Factory Default:		<input type="button" value="Set Default Config"/>
Device Firmware:	3.0.8	<input type="button" value="Update FW"/>

For more information try <http://www.hw-group.com/>

Communication monitor

Monitors whether communication with Damocles2 over selected protocols takes place, and if it doesn't within the specified time, a virtual **Comm monitor** input is activated.

Configuration

- **Save Configuration** – Stores the setup.xml file with device configuration to your HDD.
- **Load Configuration** – Uploads a XML file with the configuration from your PC.

System

- **Uptime** – Time of uninterrupted device operation (since last restart).
- **Set Default Config** – Restore factory-default settings.
- **Restart device** – Restarts the device.
- **Update FW** – Loads a .HWg firmware file from your PC to the device.

Updating Firmware

Updating the firmware over the WEB

Upload the firmware in a **.hwg** file over http to <http://x.x.x.x/upload/>. Connection interruption must be avoided during file transfer. If the update fails, upload the firmware over RS-232 as described above.

Firmware in the .HWG format is available at the Damocles website, or on the supplied CD.

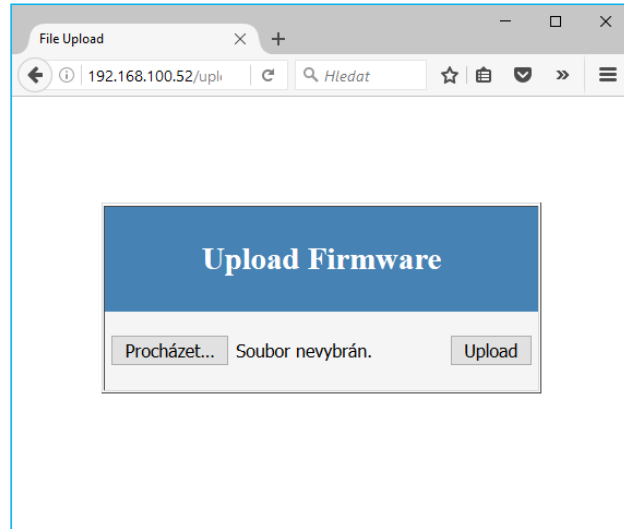

Caution: Please contact us in case of any problems with firmware upload.

Software Applications

HWg-PDMS

Windows application that logs data from all HW group devices into its internal database. The application runs in the background (NTservice). Data is retrieved from the devices over http or e-mail. Data can be exported over XML or automatically stored to MS Excel.



License:

- Free HWg-PDMS version for 3 sensors.
- Paid versions for 8/20/200/ unlimited sensors (DI inputs).

HWg-Trigger

Windows application for detecting and reacting to events.

Detects, for instance, disconnected devices, failed sensors, values out of range, or incoming SNMP Trap alerts. Possible responses include sending an e-mail, activating a relay over the network, or sending a text message (SMS) using HWg-SMS-GW. Other responses include displaying a warning message in Windows, starting an application, or shutting down the computer.

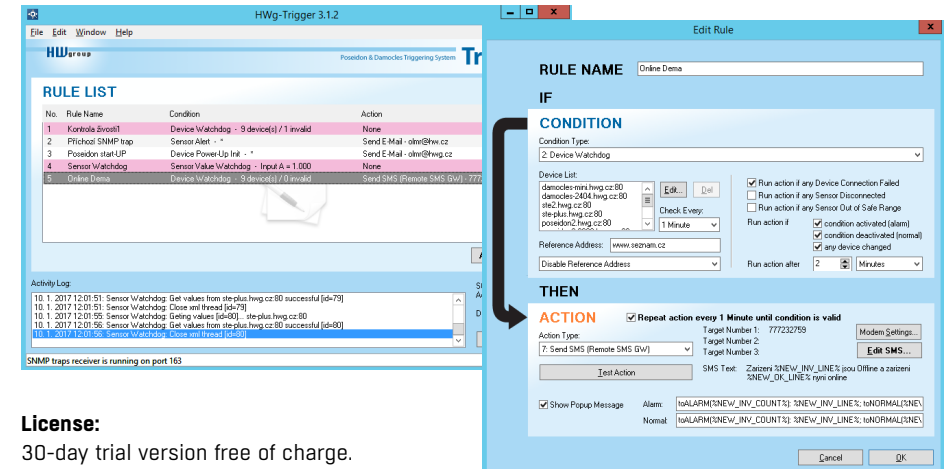

License:

30-day trial version free of charge.

SensDesk.com

Online portal for collecting data from LAN and GSM sensors.

Damocles2 can connect to the SensDesk internet service. All devices can be managed from a single WWW interface. Watch sensor states, display your devices in a map, compare trends in time and analyze alarm messages.

SensDesk is a way to implement fully functional monitoring of customer technology in a matter of minutes, with fixed costs of the system. No need for installing a complex system or adding another server at the customer side.

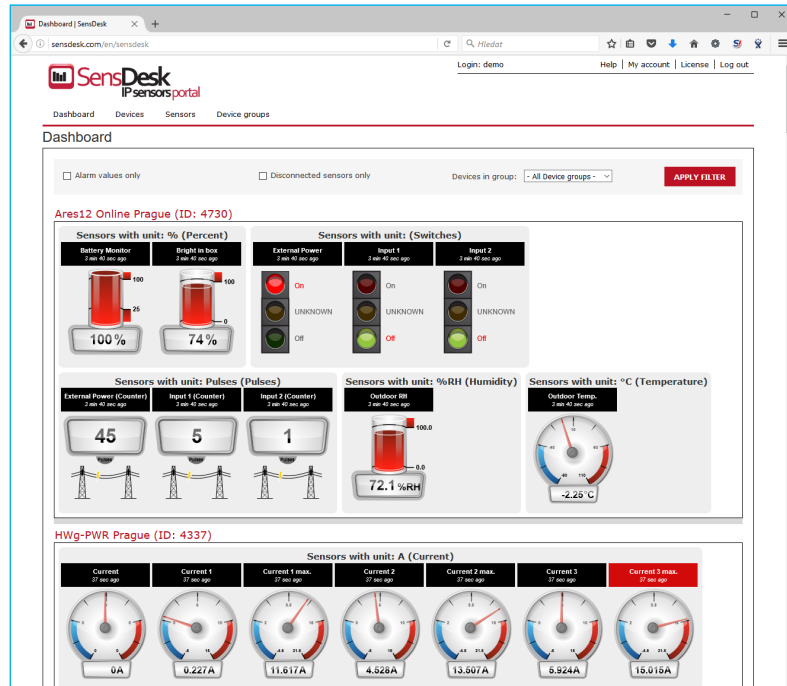

- Overview of all sensors at a single place.
- Centralized alarm configuration for individual sensors.
- Mobile application for monitoring.
- Remote configuration of GSM devices.

Damocles2 can be connected to the sensdesk.com portal similarly to Poseidon2 devices.

<http://hw-group.us/product-version/how-to-connect-poseidon2-to-sensdesk>

PosDamIO and SDK

Poseidon Damocles I/O is a command-line utility for Windows and Linux that lets you control Poseidon and Damocles units over the XML interface. It can display the states of sensors, inputs and outputs, as well as set an output high or low.

HWg SDK is a library of functions, as well as examples of their use, for Unix and Windows. The functions are intended to help third-party SW solutions communicate with our products over IP. SDK reduces the time needed to implement support for our products into your SW.

For more information:

<http://hw-group.us/cs/podpora/kba004-pouziti-damocles2-ve-vasich-programech>

```
Príkazový řádek
C:\Users\volmr.HWG\Desktop>posdamio
Usage: posdamio [OPTIONS] IP_ADDRESS [PORT (default: 80)]

Options:
-g, --get                Get actual values and print list
-o, --output X=Y        Set output X (1..64) or (151..214) to value
                        Y (0, 1, OFF, ON)
-f, --filename SETUP.XML File with configuration for uploading to the
                        remote device (max. 20000 bytes)
-v, --values VALUES.XML File to store actual values in XML format
-s, --setup SETUP.XML   File to store remote device configuration
-t, --text DATA.TXT    File to store actual values in text format
-u, --user USER         HTTP authorization user
-p, --password PASSWORD HTTP authorization password

-h, --help              Print this help and exit
--version              Display version information and exit
--error-level          Print error levels and exit

Examples:
posdamio -g 192.168.0.41
posdamio -s c:\data\setup.xml -v c:\data\values.xml 192.168.0.41
posdamio -o 1=ON 192.168.0.41
posdamio -o 1=1 192.168.0.41 8080
posdamio -f setup.xml 192.168.0.41

This application is an example of HW group. The source code you can find
in our HWg SDK on http://www.hw-group.com.

C:\Users\volmr.HWG\Desktop>
```

Specifications

Damocles2 MINI dimensions

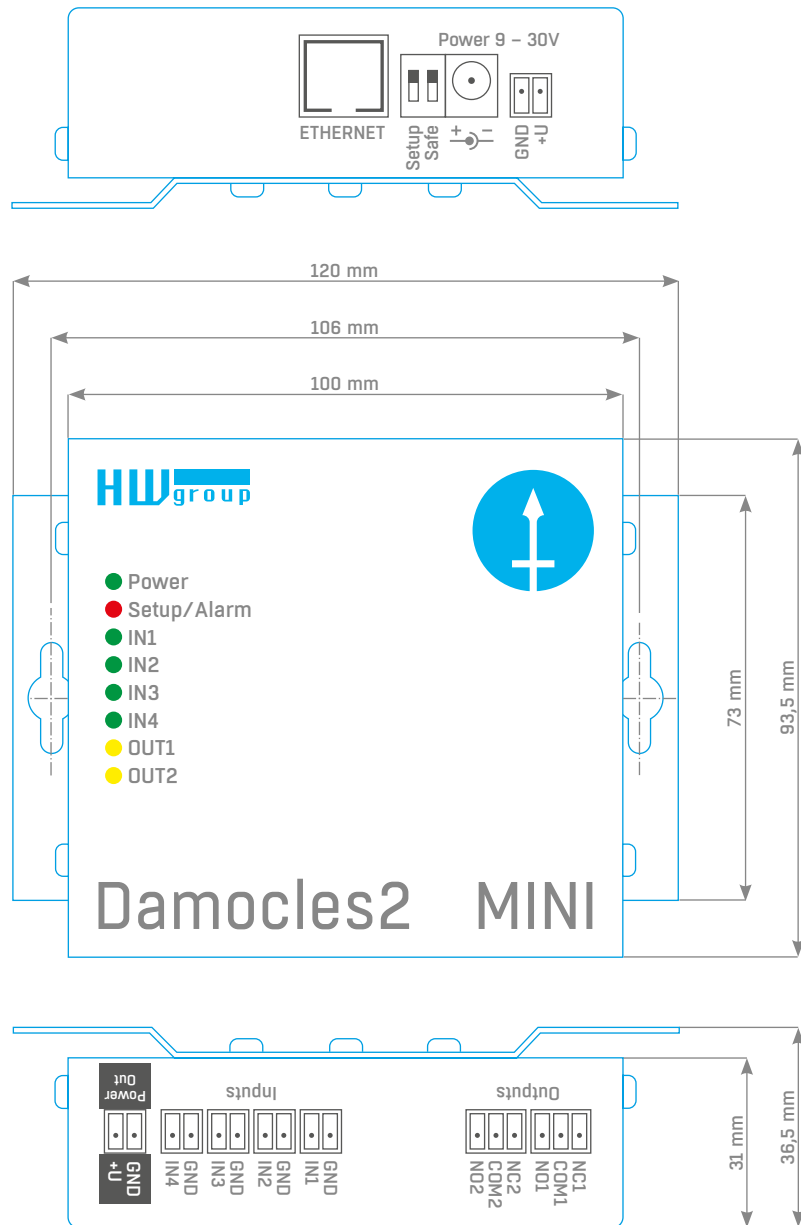

Damocles2 MINI specifications

Ethernet	
Interface	RJ45 (100BASE-Tx) – 10 / 100 Mbit
Supported protocols	ARP, ICMP, UDP / IP: SNMP, TCP / IP: HTTP, Modbus / TCP, SMTP, netGSM, HWg-PUSH, XML, IPv6, HTTPS, MQTT
SNMP compatibility	SNMPv1 + SNMPv3 compatible, partial support for v2.0

DI – Inputs (Dry contact inputs)	
Ports	I1, I2, I3, I4
Type	4× Digital Input (for a voltage-free contact, such as a NO/NC relay contact, Dry Contact)
Sensitivity	1 (On) = 0-500Ω (Up to 12 V can appear at the socket against GND)
Pulse counter	4×32-bit, min. pulse width 20ms. Counter value is retained even after power disconnection.
Max. distance	Up to 50 m

DO – Outputs	
Type	OUT1, OUT2 / Relay contacts (NC-COM-NO)
Max. load	Max. 2 A, up to 24 W (2 A / 12 V or 0.5 A / 48 V)
Power – on state	Normal (no state memory)

LED	
Power (RJ45)	Green – power OK
Link & Activity (RJ45)	Green – physical connection established, Yellow – flashes, communication taking place
Input / Output Status	Green – input, Yellow – output
Alarm	On
Setup	Flashing

DIP Switch	
DIP1: Setup	ON – Normal function mode Restoring factory defaults: Toggle the switch 3× during the first 5 seconds after powering up
DIP2: Security	ON = Security mode – configuration cannot be changed remotely OFF = Non-secure mode – configuration can be changed remotely

Parameters	
Power	9–30 VDC / 250 mA DC
Power connectors	1× barrel jack (2.5 mm, outer diameter 6.3 mm) 1× terminal block
Temperature ranges	Operation: –30 to +85 °C (+14 to +150 °F) Storage: –35 to +85 °C (–22 to +185 °F)
Dimensions / mass	106 × 31 × 94 mm / 300 g

Damocles2 1208 dimensions

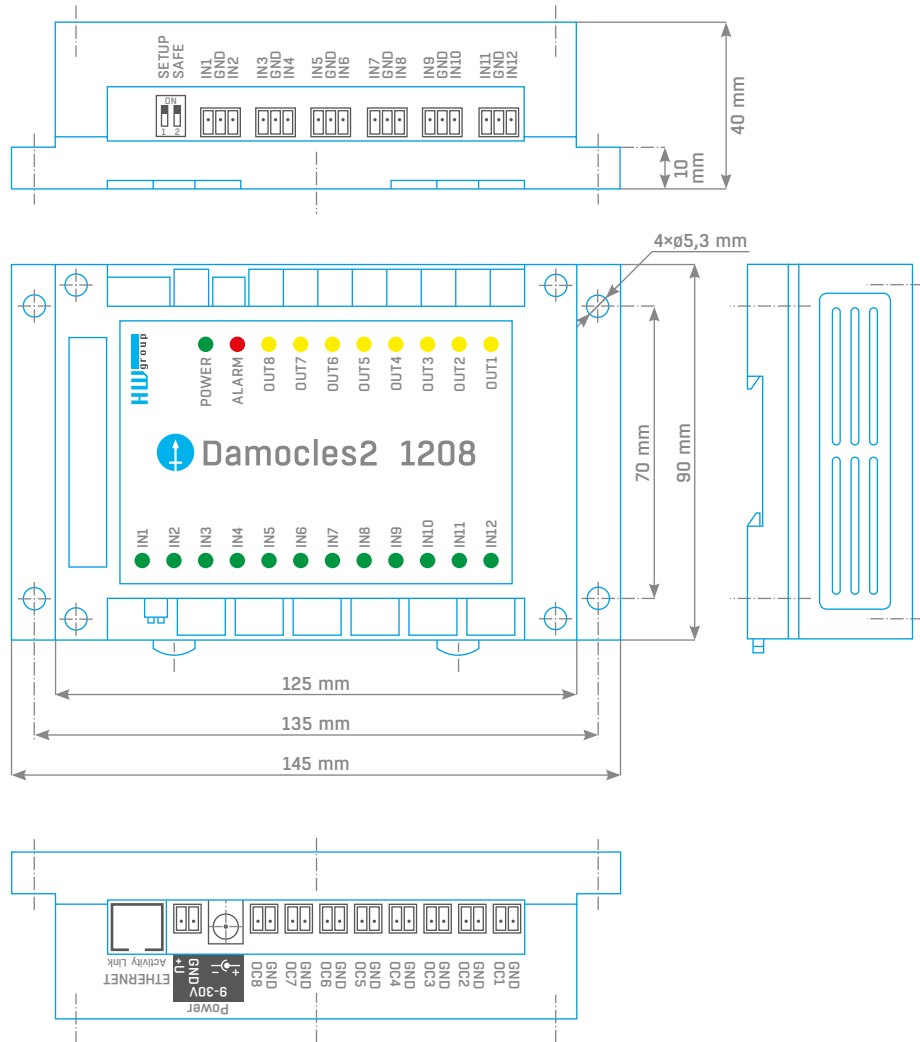

Damocles2 1208 specifications

Ethernet	
Interface	RJ45 (100BASE-Tx) – 10/100 Mbit
Supported protocols	ARP, ICMP, UDP / IP: SNMP, TCP / IP: HTTP, Modbus / TCP, SMTP, netGSM, HWg-PUSH, XML, IPv6, HTTPS, MQTT
SNMP compatibility	SNMPv1 + SNMPv3 compatible, partial support for v2.0

DI – Inputs (Dry contact inputs)	
Ports	I1 – I12
Type	12× Digital Input (for a voltage-free contact, such as a NO/NC relay contact, Dry Contact)
Sensitivity	1 (On) = 0-500Ω (Up to 12 V can appear at the socket against GND)
Pulse counter	12× 32-bit, min. pulse width 20 ms. Counter value is retained even after power disconnection.
Max. distance	Up to 50 m

DO – Outputs	
Type	8× Open collector
Max. load	50 V max. 500 mA / 1 output, max. 1500 mA / all 8 outputs

LED	
Power (RJ45)	Green – power OK
Link & Activity (RJ45)	Green – physical connection established, Yellow – flashes, communication taking place
Input / Output Status	Green – input, Yellow – output
Alarm	On
Setup	Flashing

DIP Switch	
DIP1: Setup	OFF – Normal function mode Restoring factory defaults: Toggle the switch 3× during the first 5 seconds after powering up
DIP2: Security	ON = Security mode – configuration cannot be changed remotely OFF = Non-secure mode – configuration can be changed remotely

Parameters	
Power	9–30 V / 1.7 W DC
Power connectors	1× barrel jack (2.5 mm, outer diameter 6.3 mm) 1× terminal block
Temperature ranges	Operation: -30 to +65°C (+14 to +150°F) Storage: -30 to +65°C (-22 to +150°F)
Dimensions / mass	145×40×90 mm / 222 g

Damocles2 2404 dimensions

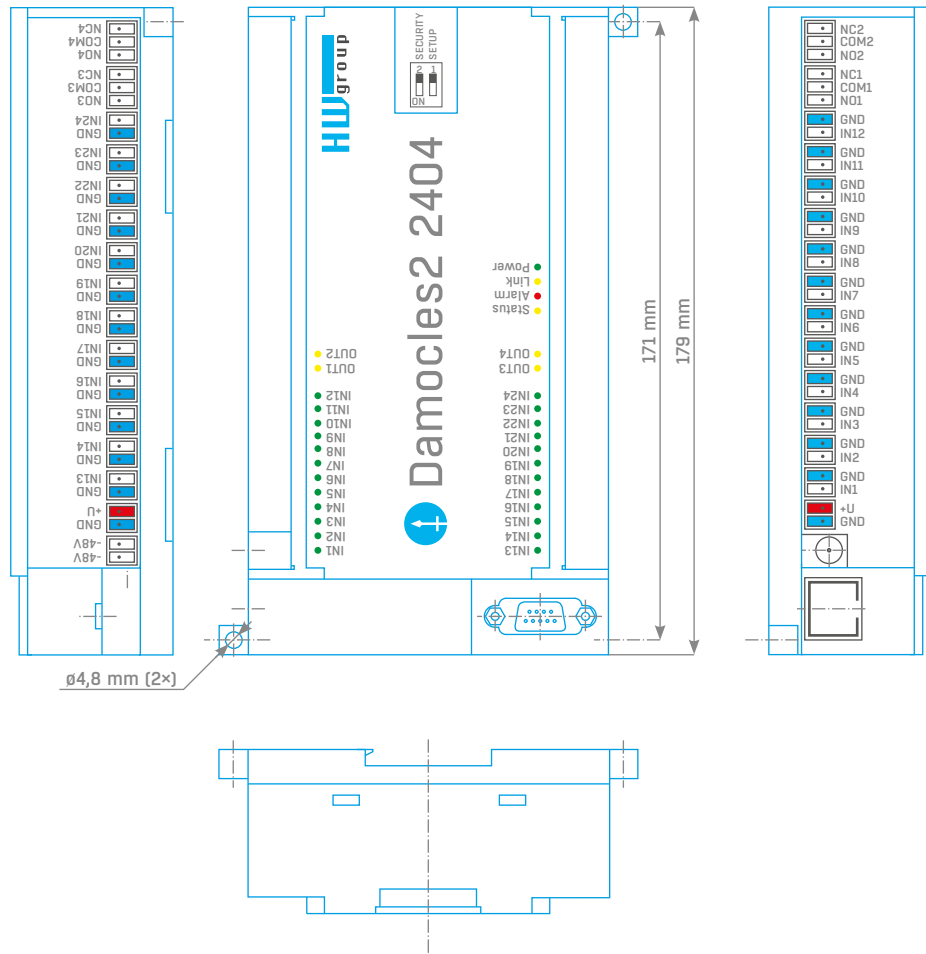
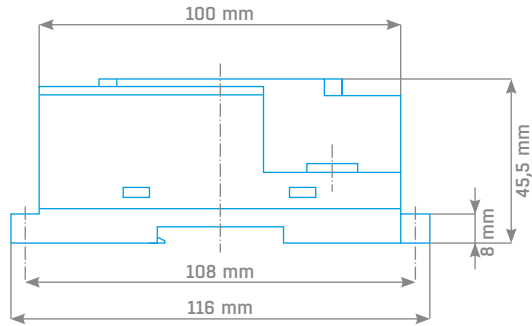

Damocles2 2404 specifications

Ethernet	
Interface	RJ45 (100BASE-Tx) - 10 / 100 Mbit
Supported protocols	ARP, ICMP, UDP / IP: SNMP, TCP / IP: HTTP, Modbus / TCP, SMTP, netGSM, HWg-PUSH, XML, IPv6, HTTPS, MQTT
SNMP compatibility	SNMPv1 + SNMPv3 compatible, partial support for v2.0

Serial port 1 DB9M - RS-232	
Connector	Cannon 9 (DB9M)
Pinout	Standard IBM PC - DB9M (RXD, TXD, RTS, CTS, GND)
Usage	Serial setup, 9600 8N1
Max. distance	2 m

DI - Inputs (Dry contact inputs)	
Port	I1 - I24
Type	24x Digital Input (for a voltage-free contact, such as a NO/NC relay contact, Dry Contact)
Sensitivity	1 (On) = 0-500Ω (Up to 12 V can appear at the socket against GND)
Pulse counter	24x 32-bit, min. pulse width 20 ms. Counter value is retained even after power disconnection.
Max. distance	Up to 50 m

DO - Outputs	
Type	OUT1 - OUT4 / Relay contacts (NC-COM-NO)
Max. load	Max. 2 A, up to 24 W (2 A / 12 V or 0.5 A / 48 V)
Power - on state	Normal (no state memory)

LED	
Power (RJ45)	Green - power OK
Link & Activity (RJ45)	Green - physical connection established, Yellow - flashes, communication taking place
Alarm & RS-232 Setup	Red - flashing - device in RS-232 Setup mode
Alarm	On
Setup	Flashing

DIP Switch	
DIP1: RS-232 Setup mode	ON = RS-232 Setup mode on Port 1 (only RS-232 setup works) OFF = Normal function mode Restoring factory defaults: Toggle the switch 3x during the first 5 seconds after powering up
DIP2: Security	ON = Security mode - configuration cannot be changed remotely OFF = Non-secure mode - configuration can be changed remotely

Parameters	
Power 1	9-30 V / consumption approx. 250 mA / 12 V DC
Power 2 (PoE)	PoE (IEEE 802.3af)
Power 3 (-48V)	-48 V DC Telco standard (-30 V to -60 V DC)
Power connector 1	1x barrel jack (2.5 mm, outer diameter 6.3 mm), + inside 2x terminal block (U+ / GND)
Temperature ranges	Operation: -30 to +65°C (+14 to +150°F) Storage: -30 to +85°C (-22 to +167°F)
Dimensions/mass	179x46x116mm / 400 g

Formats and interfaces

<http://hw-group.us/product-version/damocles2-data-formats>

XML interface description

The XML format is identical for both Poseidon2 and Damocles2 devices.

<http://hw-group.us/product-version/poseidon2-xml-format>

Modbus over TCP – Interface description

Note: For details about Modbus/TCP, see our website – **AN28: Damocles family & Modbus/TCP**.

HWg-netGSM – remote SMS gateway protocol for HW group products

For a current protocol description, see: <http://hw-group.us/cs/node/4648>.

SNMP – Interface description

<http://hw-group.us/support/kba001-snmp-popis-rozhrani>

SNMPv3

<http://hw-group.us/support/kba002-snmp-v3-jeho-vyhody-a-nasazeni-v-jednotkach-poseidon2-a-damocles2>

HTTPS in Damocles2 and Poseidon2

<http://hw-group.us/cs/podpora/kba003-https-v-jednotkach-poseidon2-a-damocles2>

HWg products



Poseidon2 3266/3268

The basic unit for monitoring temperature, humidity and other environmental conditions across LAN.



Poseidon2 3468

Remote monitoring of temperature, humidity and other environmental conditions in industrial design.



Poseidon2 4002

Unit designed for demanding monitoring applications, e.g. in data centers and industry.

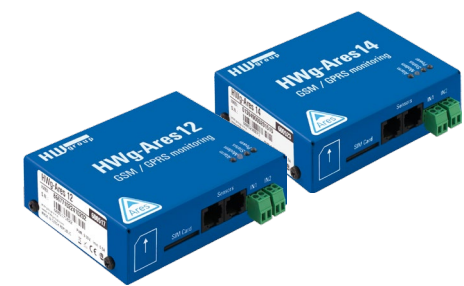

Ares 12/14

Remote surveillance of environment wherever there is GSM coverage.



HWg-WLD

Unit for detecting flooding with detection over the entire length of the sensing cable.



HWg-PWR 3/12/25

Measures power consumption using external M-Bus meters.



HW group s. r. o.
Rumunská 26/122
Prague 2, 120 00
Czech Republic

Phone: +420 222 511 918
Fax: +420 222 513 833

www.HW-group.com