

optimize!  
**softing**

# Wire **X**pert 4500



## Copper

### USER MANUAL

IT Networks



<http://itnetworks.softing.com>

## TABLE OF CONTENTS

<b>1 Introduction .....</b>	<b>4</b>
1.1 About product .....	4
1.2 Safety precautions.....	4
1.3 Intended use .....	5
1.4 About this document .....	5
1.5 Before you start .....	6
1.6 Scope of delivery .....	7
1.7 System requirements .....	7
<b>2 WireXpert PC Software and Firmware .....</b>	<b>8</b>
2.1 Install software .....	8
2.2 Upgrade firmware .....	8
<b>3 Understanding WireXpert .....</b>	<b>10</b>
3.1 WireXpert Overview .....	10
3.2 Dual Control System (DCS) .....	11
3.3 WireXpert Adapters .....	11
3.4 Cabling Certification and Testing .....	12
3.5 Memory .....	13
3.6 Battery Information.....	13
3.7 Power Supply .....	14
3.8 Dimension .....	14
3.9 Environmental Conditions .....	14
<b>4 WireXpert User Interface .....</b>	<b>15</b>
4.1 Touch Screen Layout .....	15
4.2 The One Touch Access Button .....	16
<b>5 Setting Reference .....</b>	<b>32</b>
<b>6 Configuring an AUTOTEST .....</b>	<b>33</b>
6.1 Setting up WireXpert .....	33
6.2 Testing Guide for Permanent Link Testing .....	34
6.3 Testing Guide for Channel Testing .....	35



<b>7 Performing an AUTOTEST .....</b>	<b>36</b>
7.1 Understanding AUTOTEST .....	36
7.2 NEXT and RL Fault Locating .....	38
7.3 Managing test result(s) .....	39
7.4 Exporting test results into eXport PC Software .....	40
<b>8 Declarations .....</b>	<b>45</b>
<b>9 Appendix .....</b>	<b>48</b>
<b>10 Technical Support .....</b>	<b>52</b>

## 1 Introduction

### 1.1 About product

Softing's WireXpert, with its unparalleled 2,500 MHz measurement range, is the first cable certifier with capability to certify the highest performance cabling systems in enterprise networks and data centers. Cable installers make significant gain in productivity with WireXpert's industry leading test speed and ease of use. With certification testing up to Class FA and CAT8 copper cabling, as well as MPO, SM, MM and MMEF fiber optic cabling, WireXpert is ready for 40G and beyond.

### 1.2 Safety precautions

#### Read this manual before starting



For damages due to improper connection, implementation or operation Softing refuses any liability according to our existing warranty obligations.

#### Note



This symbol is used to call attention to notable information that should be followed during installation, use, or servicing of this device.

#### Hint



This symbol is used when providing you with helpful user hints.

#### CAUTION



Selection of option may cause all or partial of saved data and/or settings in the device to be erased or restored to non-reversible original factory state. Backing up of saved result(s) is recommended before executing option.



**CAUTION**



**CAUTION** indicates a potentially hazardous situation which, if not avoided, may result in minor or moderate injury.

**WARNING**



**WARNING** indicates a potentially hazardous situation which, if not avoided, could result in death or serious injury

**DANGER**



**DANGER** indicates an imminently hazardous situation which, if not avoided, will result in death or serious injury. This signal word is to be limited to the most extreme situations.

### 1.3 Intended use

WireXpert series has been designed for use in factory, process and building control. The unit must not be used in explosion hazard areas. The permissible ambient conditions given in the Technical Data must be complied with.

The faultless and safe operation of the product requires proper transport, proper storage and installation, and expert operation and maintenance in accordance with the manual.

### 1.4 About this document

**Read this manual before starting**



For damages due to improper connection, implementation or operation Softing refuses any liability according to our existing warranty obligations.

#### 1.4.1 Document history

Document version	Modifications compared to previous version
105	Firmware update to v7.3.

Table 1: Document history

## 1.4.2 Conventions used

The following conventions are used throughout Softing customer documentation:

Keys, buttons, menu items, commands and other elements involving user interaction are set in bold font and menu sequences are separated by an arrow	Open <b>Start</b> → <b>Control Panel</b> → <b>Programs</b>
Buttons from the user interface are enclosed in brackets and set to bold typeface	Press <b>[Start]</b> to start the application
Coding samples, file extracts and screen output is set in Courier font type	MaxDisapAddressSupported=23
Filenames and directories are written in italic	Device description files are located in <i>C:\&lt;product name&gt;\delivery\software\Device Description files</i>

## 1.5 Before you start

Check that the latest eXport PC software and firmware is installed in the workstation and WireXpert respectively to ensure the latest features are available. Ensure WireXpert is calibrated annually for optimum accuracy.

### Key differences between WX4500 and WX500

Features	WX4500-FA	WX500
Frequency of measurement	2500 MHz	500 MHz
Accuracy Specification	Level 2G	Level IIIe
Fiber Testing option	Yes	No
Class FA/CAT 8 options	Yes	No
Patch Cord Test adapters	Yes	Yes



## 1.6 Scope of delivery

WireXpert WX-4500-FA or WX-500-FA comprises the following parts:



Soft or Hard carrier case  
(WX\_AC\_SOFTCASE) or  
(WX\_AC\_HARDCASE)



WireXpert WX4500 or  
WireXpert WX500  
(LOCAL and REMOTE)



Calibration Certificate  
& USB Flash Drive



Power Adapters -  
Input: 100-240VAC/0.8A  
Output: 12VDC/3.0A  
(WX\_AC\_PWRAD)



Talk-set headphones  
(WX\_AC\_TALKSET1)



LCD Protective Cover  
(WX\_LCD\_COVER)



CAT 6A Channel adapters  
(WX\_AD\_6ACH2)



Permanent Link  
adapters & cords  
(WX\_AD\_6ALKIT2)



Straps

## 1.7 System requirements

### Hardware

- PC

### Operating system

- Windows Vista, 7, 8.x or 10 (32 bit or 64 bit)
- Intel Core i3, 2.4Ghz and above
- 4 GB of RAM
- 200 MB of free space of installation
- Microsoft .NET framework 4.0

## 2 WireXpert PC Software and Firmware

### 2.1 Install software

- 1 Download the latest eXport PC software from <http://itnetworks.softing.com/>
- 2 If this is a new installation, install the files in the package in the following order
  - a. Step\_1\_drvupdate-amd64.exeb
  - b. Step\_2\_dotNetFx40\_Full\_x86\_x64.exed
  - c. Step\_3\_vcredist\_x64.exe
  - d. Step\_4\_vcredist\_x64\_mfc.EXE
  - e. Step\_5\_eXport\_setup\_v7.2.0\_x64.exe
- 3 If this is an upgrade from an earlier version from 6.x and above, install only item e.

#### User Manuals



For more information on installation and using eXport PC software, please refer to “Installation Guide for eXport PC software” and “User Manual for eXport PC software”.

#### Note



Softing IT Networks has ceased support for ReportXpert v5.x and earlier. Please contact [asia-support.itnetworks@softing.com](mailto:asia-support.itnetworks@softing.com) for more information.

### 2.2 Upgrade firmware

- 1 Download and install the latest eXport PC software.
- 2 Connect an USB flash drive to the workstation.
- 3 Run eXport PC software.
- 4 Go to **Tools** → **Update Device Firmware**
- 5 Click **[OK]** and select USB drive from “Export to USB” window.
- 6 Click **[Export]** and **[OK]** to proceed.



- 7 Please wait while exporting takes place. This process may take a while.
- 8 Remove USB flash drive from workstation and connect to WireXpert.
- 9 Select **[Upgrade Firmware]** from prompt and click **[OK]** button to continue.
- 10 If prompt did not appear, check that  USB icon is present on the status bar, and press the **[SETUP]** button →**Settings 2** →**Storage** →**USB**.
- 11 Please wait while upgrading takes place. This process may take a while.
- 12 Upgrade process is complete.

#### CAUTION



Saved test results and settings may be erased during upgrading. You are recommended to save all test results before upgrading the firmware.

## 3 Understanding WireXpert

### 3.1 WireXpert Overview

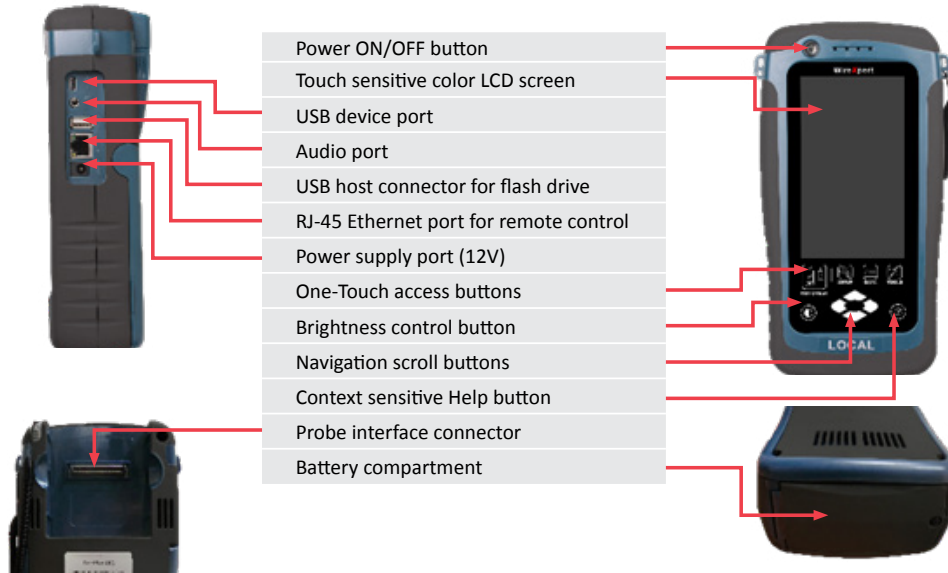

Part	Functionality
Power ON/OFF Button	To turn on the device, press the power button for 5 seconds. To turn off the device, press the power button, and select OK on the power off dialog box. Alternately, press and hold the power button for 10 seconds (not recommended). The LED in the power button turns green if the unit is turned on. The LED on the power button turns red when the device is charging in stand-by mode, orange if it's turned on.
Touch Sensitive LCD screen	Performs test executions and viewing of results.
USB device port	Enables remote connection to the PC for remote control update and exporting saved results.
Audio port	Enables vocal communication between LOCAL and REMOTE units when connected to talk set headphones (WX_AC_TALKSET).
USB Host port	Enables results to be exported and firmware upgrade via USB flash drive. Enables loading of custom limits and labels for list based testing.
RJ-45 Ethernet port	Enables communication between two sets of WireXpert for Alien Crosstalk testing
Power Supply port	Performs charging of device when connected to power adapter shipped with WireXpert. (WX_AC_PWRAD)
One-touch access buttons	Main functional buttons AUTOTEST, SETUP, DATA and TOOLS for WireXpert. Enables quick AUTOTEST and results viewing in a single click.
Brightness Control	Adjusts the brightness level of the LCD display.
Navigation scroll buttons	Performs navigation in long lists.

Part	Functionality
Context sensitive help	Provides simple explanation relevant to the functionality on the current screen (available in future version).
Probe interface connector	When connected with different probe adapters (e.g. CAT6A channel or Permanent Link), WireXpert will enable specified certification test to be conducted.
Battery compartment	Battery storage compartment. Unscrew to replace battery (WX_AC_BAT1).

### 3.2 Dual Control System (DCS)

WireXpert consists of two identical devices, LOCAL and REMOTE, for dual-end testing and certification. Both devices utilize easy to use LCD touch-screen technology and graphical user interface. The DCS ensures the same graphical data on the LOCAL units are received on the REMOTE unit real-time, improving efficiency and productivity significantly as test data and settings can be viewed from REMOTE and LOCAL side.

In the event of a wire map failure, the DCS will enable the operator on the far-end to visually identify which pair of wires is causing the error, instead of just a LED indication on traditional testers.

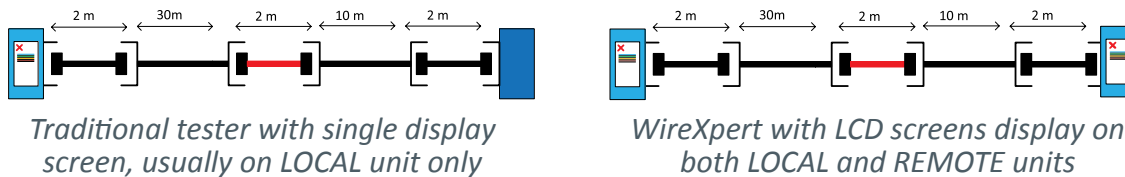

### 3.3 WireXpert Adapters

All test adapters are designed to fit onto every WireXpert units. The device automatically detects adapters when connected and prompts to change in the matching interface depending on the type of adapter. Press the **[SETUP]** button → **Quick Setup** to change the test limit using generic configurations.

#### 3.3.1 Permanent Link (PL) and Channel (Ch) Adapters

Every standard WireXpert kit includes adapters for testing copper cablings in Permanent Link and Channel configurations.

Channel adapters connect to the patch cords at the wall plates and telecommunication panels. WireXpert software compensates for the adapter's transmission characteristics to ensure test results' accuracy.

Permanent Link adapters connect to the wall plates and telecommunication panel jacks. WireXpert software compensates for the adapter's transmission characteristics to ensure test results will not be affected.

WireXpert's Permanent Link adapters' high precision interface reduces the degrading issue between the RJ-45 jack and link cord, providing highly accurate and repeatable measurements, and cost efficient method of replacing the link cords instead of the expensive link adapters.

### 3.3.2 Adapter Configuration Warnings

WireXpert will display a warning a potential conflict is detected between the adapter and the test settings. It is important to use the appropriate adapters as accuracy of measurements will be affected.

### 3.3.3 Adapter Insertion Counts

Every WireXpert adapter can keep track of the number of tests performed. This data ensures up to date information on the adapter's lifespan. WireXpert will indicate a warning when the adapter insertion counts has expired the specified insertion counts lifespan. This can be checked by pressing the [SETUP] button → **System Settings 2** → **Device Info** → **Probe Test Count**

## 3.4 Cabling Certification and Testing

Certification testing with WireXpert is highly intuitive and simple. The AUTOTEST function performs a series of measurements between the LOCAL and REMOTE devices and analyses the results to determine if the cabling run passes or fails the selected standards.

### 3.4.1 Copper Cable Certification Testing

Test at both ends of structured twisted pair cables for the worst case performance are required in accordance to the ISO/TIA standards. All certification testing requires a two-part test consisting of a main and remote unit, both bearing similar test capabilities. The test would be conducted with one end from the telecommunication closet, and the other at the outlet.

There are two primary considerations regarding the test method:

- Whether the user patch cords are included in the cabling run during the test.
  - If so, channel test configuration is required.
  - If not, link test configuration is required.
- Which standard – TIA or ISO should be used (Category or Class)

### 3.4.2 Permanent Link Configuration Tests

The Permanent Link configuration is generally used in facilities still under construction and does not include user patch cords. As the link configuration does not include the two additional connections of the patch cords, performance standards are more stringent. Special link adapters are used on both LOCAL and REMOTE units for links that are under test.

### 3.4.3 Channel Configuration Tests

User patch cords are included for the Channel configuration. The pass/fail limits for this configuration allows performance degradation inherent in the two additional patch cords included in the measurements, thus are less stringent. Special channel adapters are used on both LOCAL and REMOTE units for channels that are under test.



## 3.5 Memory

1 Gigabyte internal flash memory.

External USB Flash Drive included allows for flexible data management and storage.

WireXpert only supports FAT/FAT32/exFAT file system.

### 3.5.1 Memory Requirements

The amount of memory that each test result takes up depends on the options that is configured before starting the test. If plots are saved with each test, file size of test results will be generally larger than one that has plots option omitted.

WireXpert allocates approximately 1 GB of internal flash memory for test result storage.

## 3.6 Battery Information

WireXpert units are powered by Lithium Ion rechargeable batteries. These batteries contain circuitry that reports their state of charge to WireXpert. The units can be powered by external AC/DC power adapters.

A fully charged battery can operate WireXpert for five to eight hours before requiring recharging. Reducing the screen brightness and enabling the sleep function allows WireXpert to run longer on a charge.

### WARNING



Do not set reference or operate WireXpert while the battery is hot immediately after charging. Make sure that the WireXpert is always operated within the allowed temperature range from 0-40°C. If a significant increase or decrease of the temperature is discovered, repeat the set reference procedure to remain the instrument's accuracy.

### CAUTION



Use only the supplied power supplies with the WireXpert kit. Using other powers may damage the tester and void its warranty.

### 3.6.1 Battery Safety

- To avoid the risk of fire, burns or damage to your battery pack, do not allow metal objects to touch the battery contacts.
- The battery pack is suitable for use only with compatible WireXpert devices.
- Do not disassemble the battery pack. There are no user serviceable parts inside. Do not dispose the battery pack in fire or water.
- Handle a damaged or leaking battery with extreme care. If you come into contact with the electrolyte, wash the exposed area with soap and water. If the electrolyte contacts the eye, flush the eye with water for 15 minutes and seek medical attention.
- Do not expose the battery pack to high storage temperatures (above 55°C).
- When discarding a battery pack, contact your local waste disposal provider regarding local restrictions on the disposal or recycling of Lithium Ion batteries.
- To obtain a replacement battery (part number WX\_AC\_BAT1), contact your local dealer.
- Do not charge the batteries pack if the ambient temperature is above 40°C.

## 3.6.2 Replacing Battery

The batteries are located and secured at the bottom of the WireXpert units for safety reasons. To replace the batteries;

1. Switch off WireXpert and disconnect external power supplies.
2. Unscrew the battery compartment and remove the cover.
3. Remove and replace a new battery into the compartment.
4. Close, fasten and secure the screw onto the compartment cover.



## 3.7 Power Supply

- Removable/rechargeable Li-Ion batteries provide more than 8 hours of continuous operation.
- AC power: 100~240V AC plugs directly into the battery. Alternatively, the batteries can be recharged using an external charging kit that can be ordered separately (WX\_AC\_CHARGER).

## 3.8 Dimension

- Size: 220mmH x 110mmW x 53mmD
- Weight: approx. 1.0 kg (approx. 2.2 lbs.)

## 3.9 Environmental Conditions

- Operating temperature: 0°C to 40°C
- Storage Temperature: 20°C to 60°C
- Relative humidity: 10% to 80%

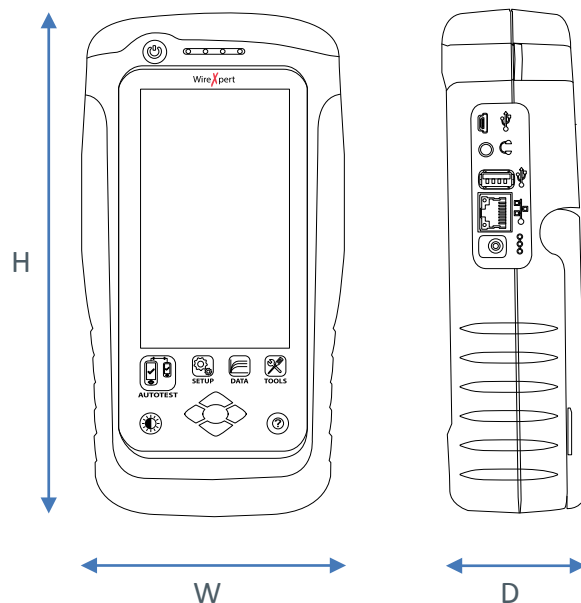

## 4 WireXpert User Interface

### 4.1 Touch Screen Layout

The Graphical User Interface (GUI) in version 7.0's firmware has been updated with a more responsive system and quick-access menus.

WireXpert boots up to the SETUP screen. It is categorized into 5 groups:

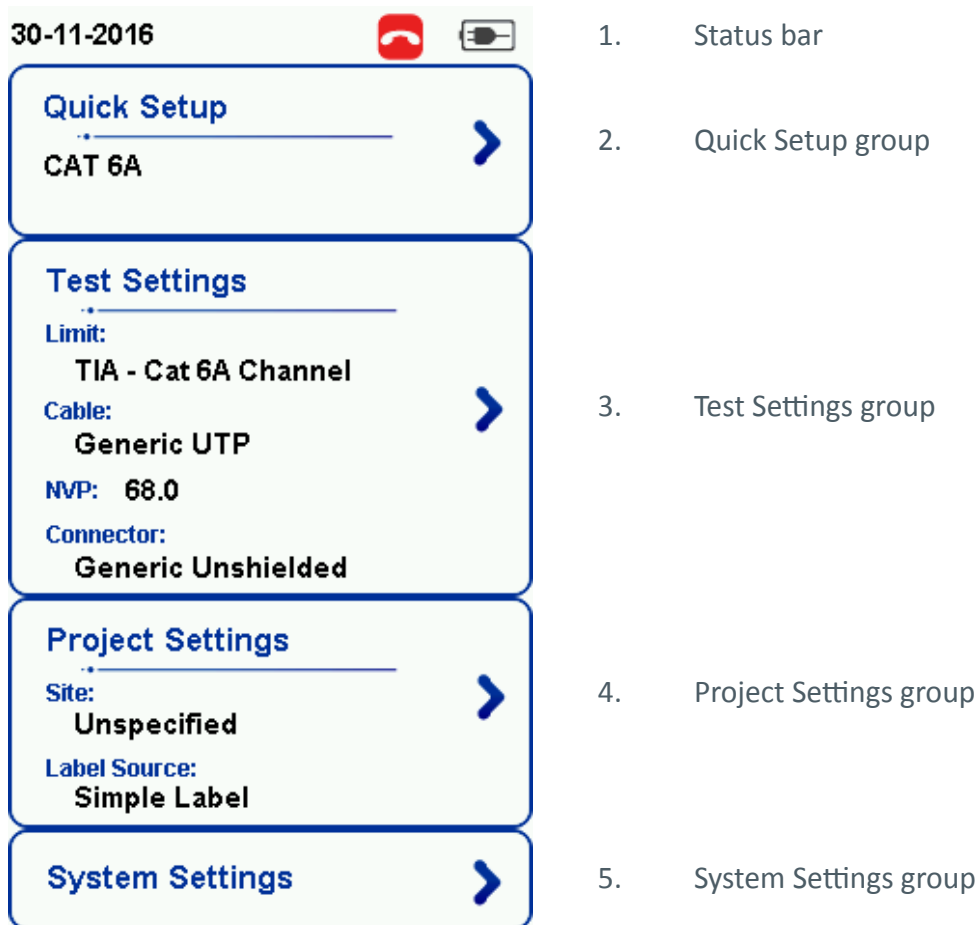

1. The **Status bar** displays the current date and time, talk set and battery level. Tap icons to change/view setting.
2. The **Quick Setup** group provides quick selection with predefined configurations.
3. The **Test Settings** group provides results oriented configurations necessary to perform an AUTOTEST.
4. The **Project Settings** group provides non-results oriented configurations before performing an AUTOTEST.
5. The **System Settings** group settings provides device, time, localization and device related configurations.

## 4.2 The One Touch Access Button



The fundamental philosophy behind the WireXpert User Interface is simplicity in its ease of use. The main functions of the One-Touch access buttons as follows:





### 4.2.1 The [AUTOTEST] button



The [AUTOTEST] button will perform an immediate certification test on the last configured settings. If no settings were configured, default settings will be used.

Test results will be generated automatically after the test is completed.

You will receive any of the following 4 results after performing AUTOTEST:

-  Green "PASS" – Good test result in accordance to pre-defined settings.
-  Green "PASS\*" – "PASS" result with one or more test parameters that have margin in the range of uncertainty of the tester.
-  Red "FAIL" – Unacceptable results with severe disturbance on one or more test parameters.
-  Red "FAIL\*" – "FAIL" result with one or more test parameters that have negative margin in the range of uncertainty of the tester.



#### Note

Marginal Pass/Fail is enabled by default. Press the [SETUP] button → Test Settings → Test Options → Lab → Marginal Pass/Fail to change the presentation of the test result to clear "PASS" or "FAIL" results. Uncertainty of the tester is then not taken into account. Contact Softing for more information.

You will be given the following option after performing an AUTOTEST:

- [Retest] can be conducted on a PASS or FAIL result (if list based testing labelling scheme is selected).
- [View] details will display additional test parameters and plots.
- [Save] test results to device

An AUTOTEST will fail in the event of missing connection between the LOCAL and REMOTE units, wrong settings configured or if setting reference are required. WireXpert will perform an initial wire map test before testing other parameters. Disable wire map test at Test Settings → Test Options → Lab → Wire map to bypass this test.





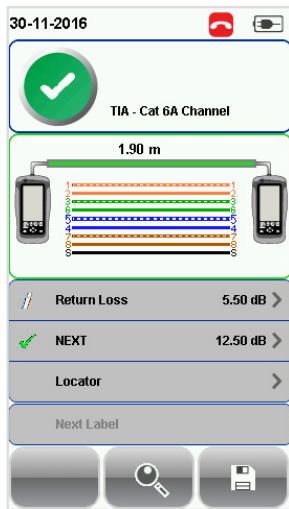

AUTOTEST results

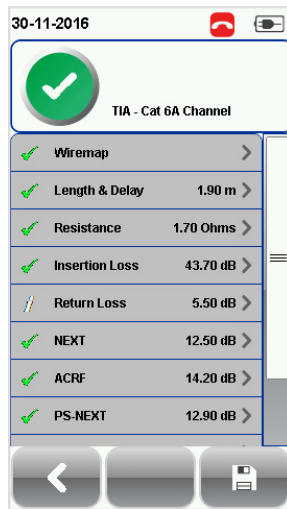

[View] detail results

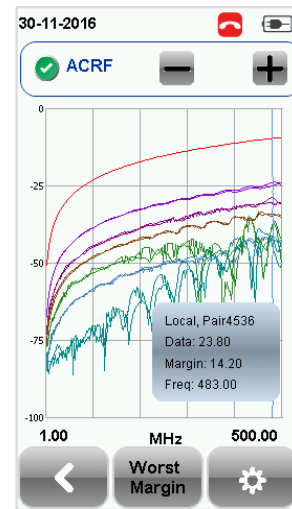

Plots

Two worst tested parameters will be displayed on the result summary screen. Press the **[View]** button to view detailed results.

The type of results will differ depending on the Test Limits and type of cable.

Test results on the screenshots are for illustration purposes only and not to be taken as reference values.

## 4.2.2 The [SETUP] button



The **[SETUP]** button provides setting options necessary to conduct an AUTOTEST and configure the device.

These options include –

### 4.2.2.1 Quick Settings

Quick Settings provides quick selection using predefined TIA (CAT 5e/6/6A) and ISO (Class D/E/EA/FA) configurations for UTP/FTP cables. WireXpert will detect if Channel or Permanent Link adapter is used and changes its test limits automatically.

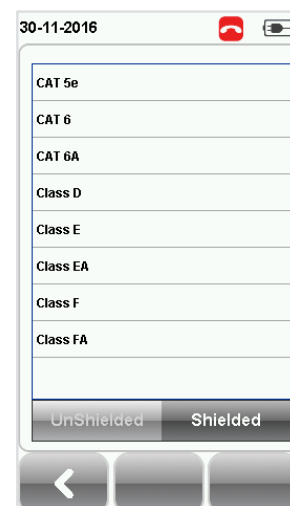
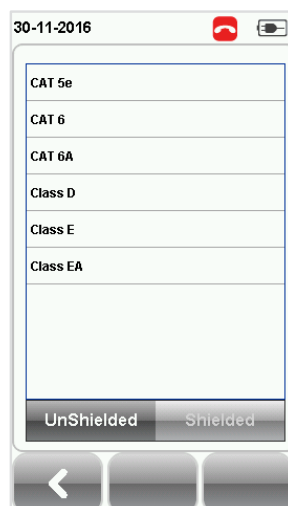

## 4.2.2.2 Test Settings

Test Settings provides results oriented configurations necessary to perform an AUTOTEST including:-

### 4.2.2.2.1 Test Limit

Choose from a list of standards to determine the performance criteria in a given category or class. Three of the most commonly used limits will be listed in the “Recent Limit” list.

Press the [SETUP] button → **Test Settings** → **Test Limits** to choose from a list of commonly used limits. Three recently used limits will be on top of the list.

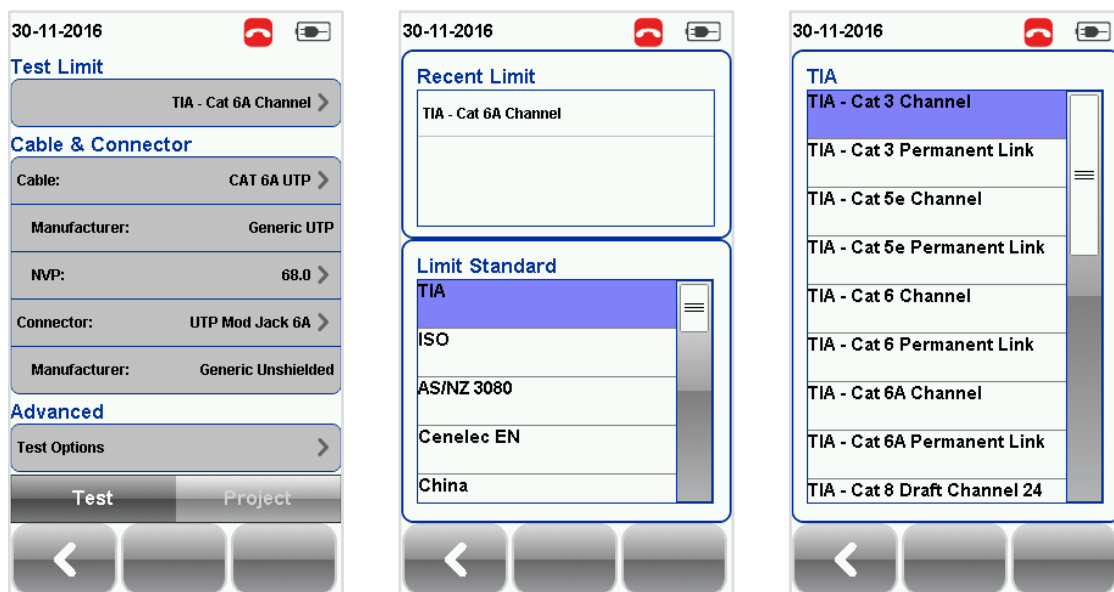

### 4.2.2.2.2 Cable

Choose from a list of cable manufacturer for more specific test parameters. If unsure of manufacturer, choose [Generic UTP] or [Generic Shielded], or [Customized Cable] to create custom cable.

Press the [SETUP] button → **Test Settings** → **Cable Manufacturer** to choose from a list of cable manufacturers. If unsure of manufacturer, choose [Generic UTP] or [Generic Shielded], or [Customised Cable] to create custom cable.

#### *Customized Cable*

Click [Add] to add or [Delete] to remove customized cable(s) from the customised cable list.

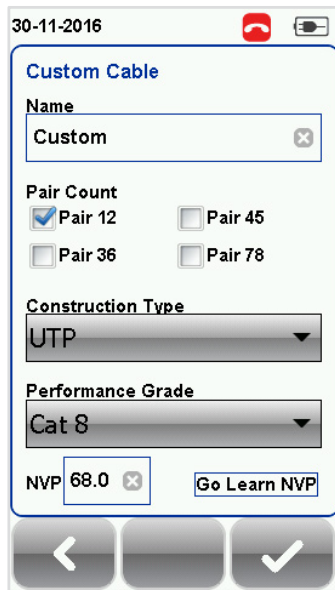
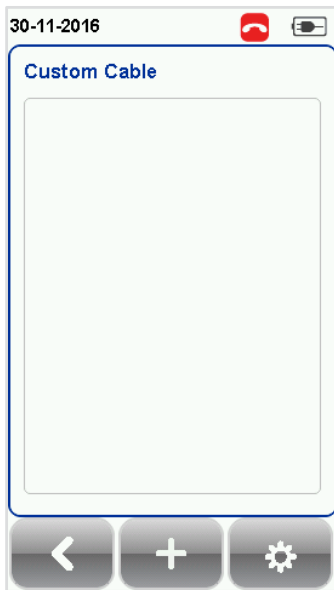

Add customised cable

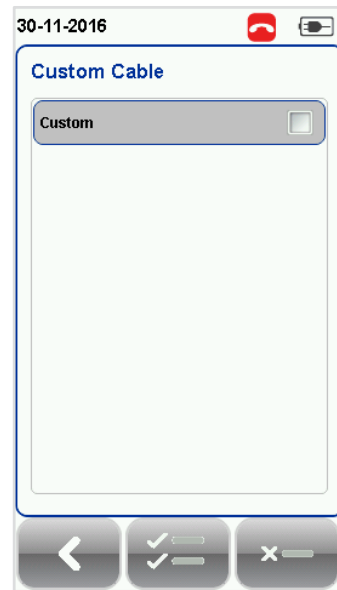

Manage customised cables

When creating customised cable, determining the cable name, number of pairs, construction type, performance grade(S/FTP) and cable's NVP is required.



WireXpert introduces the **[Manage]** button on version 7.0 firmware. **[Manage]** enables multiple saved items such as sites, operators, customized cables, customized connectors and results to be selected and deleted simultaneously.

#### 4.2.2.2.3 NVP

Determine the Nominal Velocity of Propagation (NVP) value of the cable. The NVP factor is required to determine the accurate length of the cable run to be measured. Based on this constant value, the WireXpert performs its TDR calculations. Please see the cable's data sheet for the specific value of the cable type in use.

If the specific NVP value is unknown, press the **[TOOLS]** button → **Learn NVP** to determine the value using the predefined cable run of at least 30 meters or 100 feet.

#### 4.2.2.2.4 Connector

Press the **[SETUP]** button → **Test Settings** → **Connector Manufacturer** to choose from a list of connector manufacturers. If unsure of manufacturer, choose **[Generic UTP]** or **[Generic Shielded]**, or **[Customised Connector]** to create custom connector.

Click **[Add]** to add or **[Delete]** to remove customised connector(s) from the customised connector list.

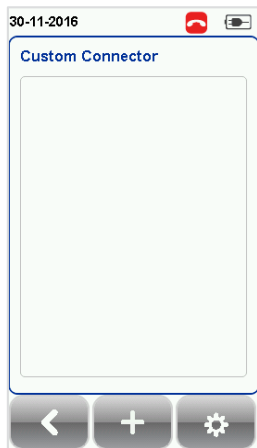

*Add customized connector*

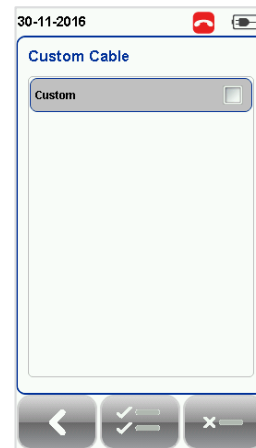
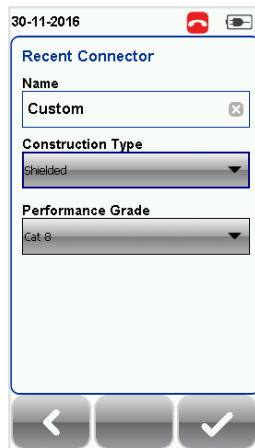

*Manage customized connector*

#### 4.2.2.2.5 Advanced Test Options

Advanced Test Options determines how the test will be conducted and results will be displayed.

##### General

- Locator – If enabled, WireXpert will display NEXT and Return Loss (RL) fault information in an AUTOTEST result. Disabled by default.
- Cable Pairing Type – Choose T568A or T568B copper cable wiring standard. “B” selected by default.
- Start AUTOTEST On Connection – If enabled, WireXpert will perform AUTOTEST as soon as a connection between LOCAL and REMOTE is established. Disabled by default.
- Direct Attach – If enabled, WireXpert will perform Direct Attach copper installation test. Attach Permanent Link adapter to the LOCAL and Patch Cord adapter to the REMOTE unit to perform this test. Connect LOCAL unit to patch panel and REMOTE to field terminated end. Disabled by default.
- AC Wire map – If enabled, WireXpert is able to measure test runs with Power over Ethernet (PoE) midspan devices in between. The WireXpert supports cable runs with IEEE 802.3 af and 802.3 at injectors. Disabled by default.

##### Lab

Laboratory use only. Please contact your local WireXpert Vendor for more information.

- WireMap Test – If enabled, WireXpert will not ignore failed wire maps during test. Enabled by default.
- Marginal Pass/Fail – If enabled, WireXpert will display marginal pass (PASS\*) and marginal fail (FAIL\*) results. Enabled by default.
- Save Phase Data – If enabled, WireXpert will generate information for phase data plot generation. Export saved results to CSV format using eXport software to obtain phase data. Impedance plot will be displayed on eXport. Disabled by default.
- 3/4 dB Rule – If enabled, WireXpert will ignore RL failures if Insertion Loss (IL) is <3dB and NEXT failures if IL is <4dB. Disabled by default.

### 4.2.2.3 Project Settings

Project Settings provides non-results oriented configurations before performing an AUTOTEST.

#### 4.2.2.3.1 Site

To add a site,

1. Press the **[SETUP]** button → **Project Settings** → Site to begin adding a new site.
2. Click the **[Add]** button to add a new site.
3. Enter a Site Name. Site Name is a required field. Test results and label source will be saved under the created Site.
4. Site Address and Site Notes are optional fields, but they provide additional information of the site.
5. Press **[OK]** to save site and proceed.

By default, WireXpert creates an “UNSPECIFIED” site for default saving as long as new sites are not created.



To delete a saved site,

1. Press the **[Manage]** button.
2. Select site(s) and press the **[Delete]** to delete site(s).



WireXpert introduces the **[Manage]** button on version 7.0 firmware. **[Manage]** enables multiple saved items such as sites, operators, customized cables, customized connectors and results to be selected and deleted simultaneously.

#### 4.2.2.3.2 Operator

To add an operator,

1. Press the **[SETUP]** button → **Project Settings** → **Operator** to begin adding an operator.
2. Click the **[Add]** button to add a new operator.
3. Enter Operator Name.
4. Press **[OK]** to save site and proceed.

By default, WireXpert creates an “UNSPECIFIED” operator for default saving if new operators are not created.



To delete a saved operator,

1. Press the **[Manage]** button.
2. Select operator(s) and press the **[Delete]** to delete operator(s).

#### 4.2.2.4 Label Source

Press the **[SETUP]** button → **Test Settings** → **Label Source** to choose from a list of scheme.

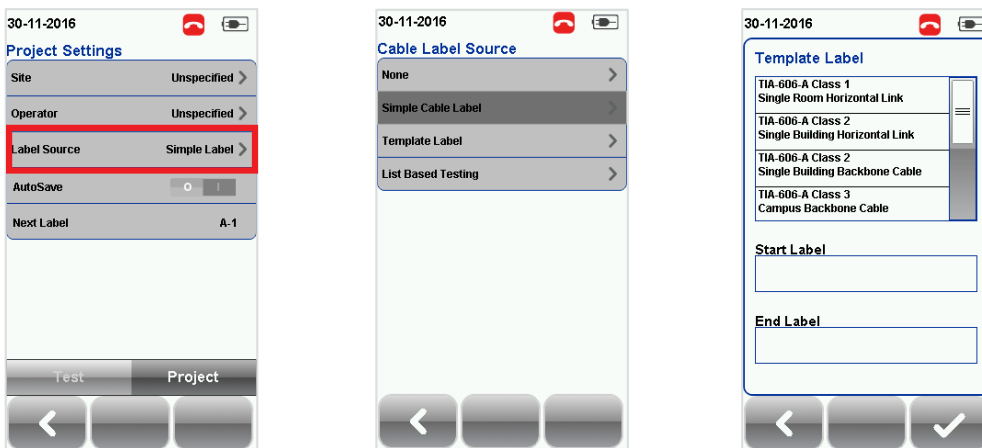

*Template Label*

#### 4.2.2.4.1 Template Label

##### None

Manual input of label names is required for every saving of result.

##### Simple Label

Provides simple numeric increments to a prefix. To configure the simple label scheme:

1. Label Name - Enter desired Prefix (e.g. Office, Company X) for every label.
2. Start Value - Set a numeric start value (e.g. 1, 33, 245) for incremental counts.

### ***TIA-606-A Class 1 (Single Room Horizontal Link)***

TIA-606-A Class 1 standard labelling scheme mainly used to support labelling for a building or premises that is served in a single equipment room or a horizontal cross-connect.

The default “1A-A1” generally refers to “Floor + Tel Room – Panel + Port”.

### ***TIA-606-A Class 2 (Single Building Horizontal/Single Building Backbone Cable)***

TIA-606-A Class 2 standard labelling scheme mainly used to support labelling of infrastructure with one or more telecommunication spaces in a single building.

The default “1A-A1” for Horizontal Link generally refers to “(1) Floor + (A) Tel Room – (A) Panel + (1) Port”.

The default “1A/1B-” for Backbone Cable generally refers to “(1)Tel Room 1 Floor + (A)Tel Room 1 Name / (1)Tel Room 1 Floor + (B)Tel Room 2 Name” followed by - “Backbone Cable . Cable”

30-11-2016

Template Label

- TIA-606-A Class 1  
Single Room Horizontal Link
- TIA-606-A Class 2  
Single Building Horizontal Link**
- TIA-606-A Class 2  
Single Building Backbone Cable
- TIA-606-A Class 3  
Campus Backbone Cable

Start Label  
1A-A1

End Label  
2B-B6

30-11-2016

Template Label

- TIA-606-A Class 1  
Single Room Horizontal Link
- TIA-606-A Class 2  
Single Building Horizontal Link
- TIA-606-A Class 2  
Single Building Backbone Cable**
- TIA-606-A Class 3  
Campus Backbone Cable

Start Label  
1A/1B-

End Label  
1A/1B-

### **TIA-606-A Class 3 (Campus Backbone Cable)**

TIA-606-A Class3 standard labelling scheme mainly used to support labelling for multiple buildings in a single site.

The default “A-1A/A-1A-” generally refers to “(A)Building 1 Name - (1)Tel Room 1 Floor + (A)Tel Room 1 Name / (A)Building 2 Name – (1)Tel Room 2 Floor + (A) Tel Room 2 Name” followed by - “Backbone Cable . Cable”

30-11-2016

Template Label

- TIA-606-A Class 1  
Single Room Horizontal Link
- TIA-606-A Class 2  
Single Building Horizontal Link
- TIA-606-A Class 2  
Single Building Backbone Cable
- TIA-606-A Class 3  
Campus Backbone Cable**

Start Label  
A-1A/A-1A-

End Label  
A-1A/A-1A-

### **Free Form**

Free Form provides simple numeric increments to 2 or more prefix.

The default start “A-1” and end “B-5” labels will generate labels “A1 to A5 and B1 to B5”.



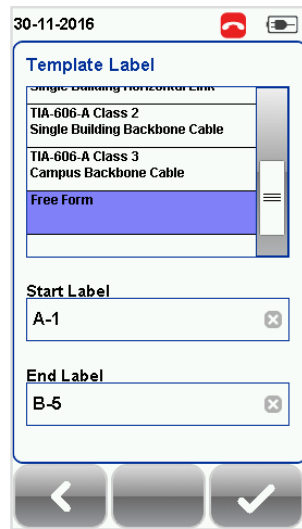

### List Based Testing

List based testing allows creation of label list in the eXport software on PC and then bring the list to WireXpert. It further allows easy selection of labels from the list to help technician select the cables to be tested quickly. This testing method is carefully optimized for typical test work-flow, and it significantly improves productivity.

1. Insert USB flash drive to USB port on WireXpert.
2. Device will automatically detect USB flash drive.
3. Select **[Label List]**.
4. Select the custom label list(s) to be copied from the USB flash drive.
5. Select **[Copy label files]** to proceed.
6. Click **[OK]**.

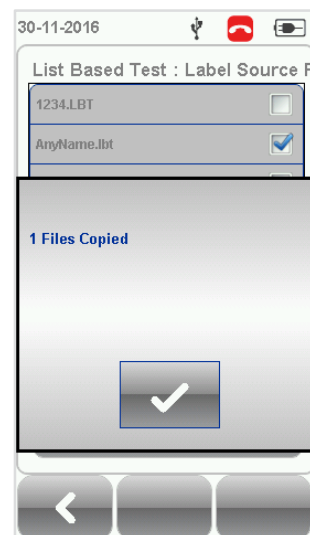
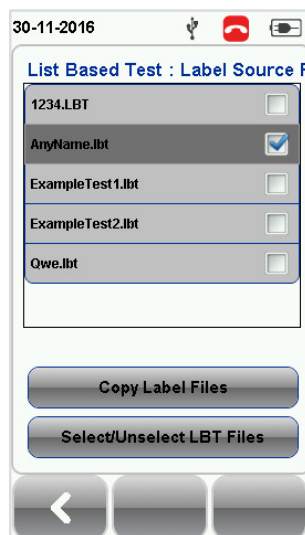
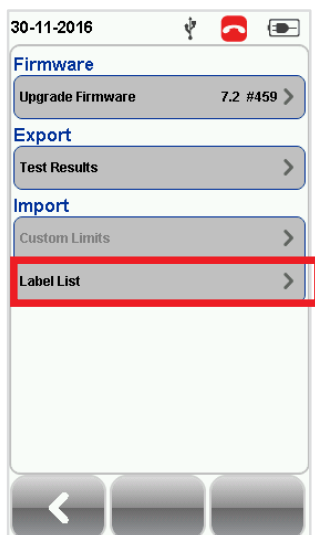

7. Press the **[SETUP]** button → **Project Settings** → **Label Source** → **List Based Testing**
8. Select label source file and click **[OK]** to continue.



## User Manuals

Refer “User Manual – eXport” for more information on generating list based labels.

9. Press the **[AUTOTEST]** button to display the loaded cable list.
10. Select label from list to begin AUTOTEST.
11. WireXpert will automatically save a PASS result and return to the list, or allows you to save or conduct a re-test for a FAIL result manually.
12. Select a tested label to view the results. A green result indicates a PASS and a red result indicates a FAIL test. A re-test can be conducted by pressing **[Retest]**.
13. Press the **[AUTOTEST]** button to return to the list.

### 4.2.2.4.2 AutoSave



Enable option for WireXpert to auto save every PASS result. Option will be enabled for List Based Testing

### 4.2.2.5 System Settings

#### 4.2.2.5.1 Length Unit



Press the **[SETUP]** button → **System Settings** → **Settings** → **Device Settings** **Length Unit** to select the preferred length unit to be displayed. Feet (FT) and Meters (M) are available.

#### 4.2.2.5.2 Plot Y-axis Direction



Press the **[SETUP]** button → **System Settings** → **Settings 1** → **Device Settings** → **Plot Y-axis Direction** to select the how the plot's Y-axis will be display. Normal and Inverted Y-axis are available.

#### 4.2.2.5.3 Sleep and Auto Power-off Interval

For Sleep Interval,

Press the **[SETUP]** button → **System Settings** → **Settings 1** → **Sleep Interval** to select the idle duration before WireXpert enters the sleep (power saving) mode.

For Auto Power-off Interval,

Press the **[SETUP]** button → **System Settings** → **Settings 1** → **Auto Power-Off Interval** to select the idle duration before WireXpert performs an automatic shutdown.



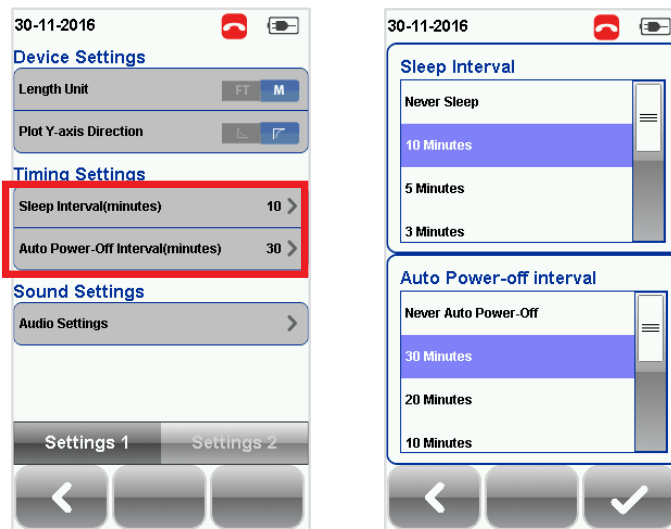

#### 4.2.2.5.4 Audio Settings

Press the [SETUP] button → System Settings → Settings 1 → Audio Settings to configure various audio options for WireXpert.

- Touch Click – Enable option to trigger clicking sound options on screen touch.
- Speaker & Tone – Enable option to trigger system sound options, e.g., boot up.
- Voice Prompt – Enable option to trigger system vocal notifications on action.
- Volume Control – Adjust for audio loudness.

#### 4.2.2.5.5 Date and Time

Press the [SETUP] button → System Settings → Settings 2 → Date & Time to configure date, time and display format.

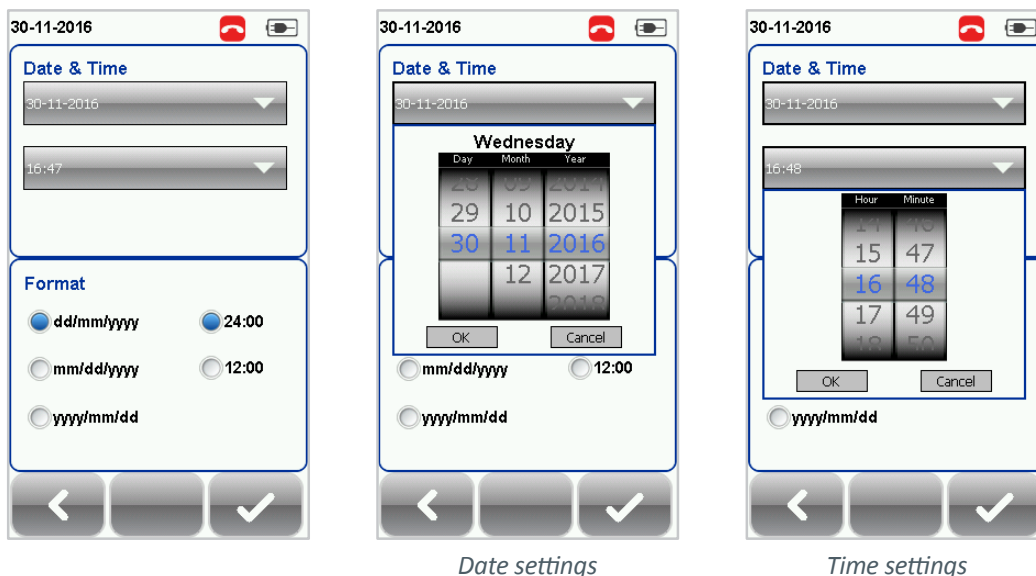

#### 4.2.2.5.6 Language

Press the [SETUP] button → System Settings 2 → Language to select preferred display language.

## 4.2.2.5.7 Storage

Press the [SETUP] button → **System Settings** → **Settings 2** → **Storage** to view available storage space on WireXpert and USB flash drive if inserted.

Read USB flash drive by clicking the USB icon if prompt did not appear or closed after inserting USB flash drive.

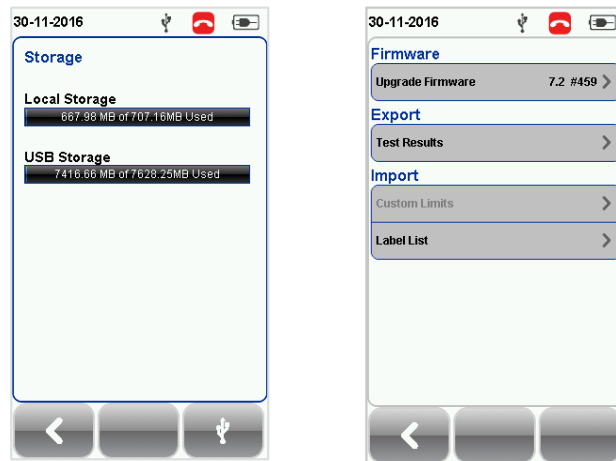

*Read USB flash drive*

## 4.2.2.5.8 Battery

Press the [SETUP] button → **System Settings** → **Settings 2** → **Battery** to view battery level. Battery levels of LOCAL and REMOTE will be displayed if units are connected.

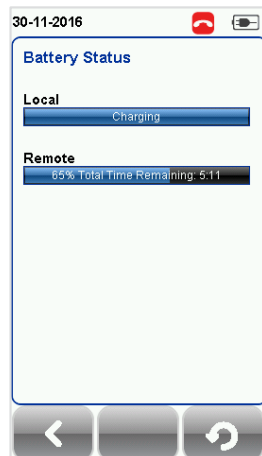

## 4.2.2.5.9 Restore Factory Settings

Press the [SETUP] button → **System Settings 2** → **Settings 2** → **Restore Default Settings** to restore WireXpert to factory settings. Click [OK] to begin restoration.

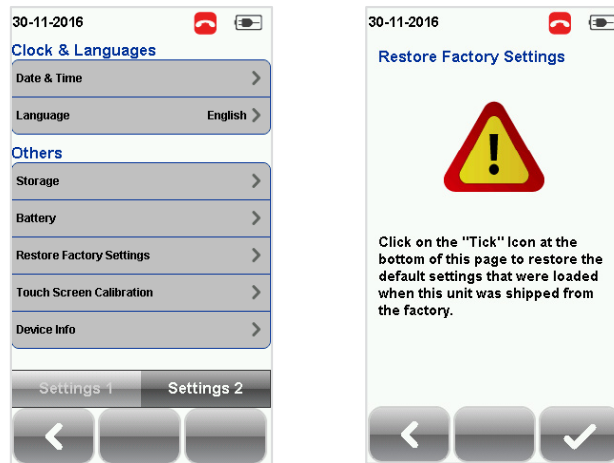

#### CAUTION



Restoring WireXpert to default settings is an irreversible action. All user defined settings and stored test results will be erased and cannot be recovered.

#### 4.2.2.5.10 Touch Screen Calibration

Press the [SETUP] button → **System Settings** → **Settings 2** → **Touch Screen Calibration** to re-adjust mechanical alignments of the touch screen. Follow on-screen instructions to begin calibration.

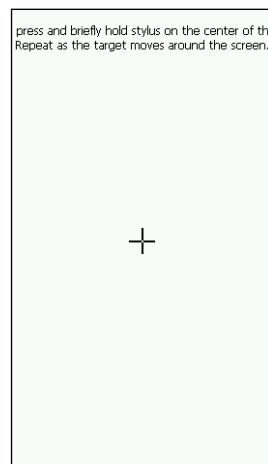

#### 4.2.2.5.11 Device Info

Press the [SETUP] button → **System Settings** → **Settings 2** → **Device Information** to check the device and probe serial numbers, software and hardware version numbers, device last calibrated date and probe test count.

Click on the [**Device Info**] button for more information on the firmware.

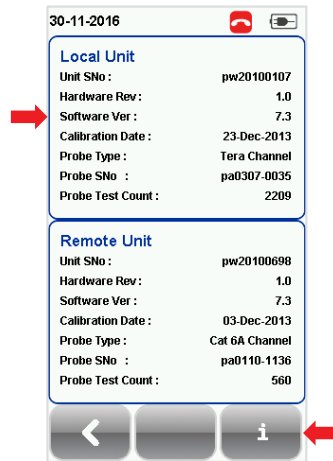

## Note



To ensure accurate test results, it is recommended to have WireXpert units calibrated every year. Contact vendor for more information.

### 4.2.3 The [DATA] button



The [DATA] button provides archive and data management ability to saved sites and test results. Saved test results can be renamed or deleted in this option.

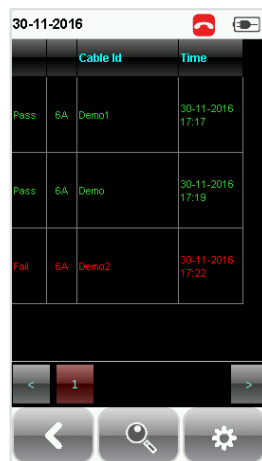
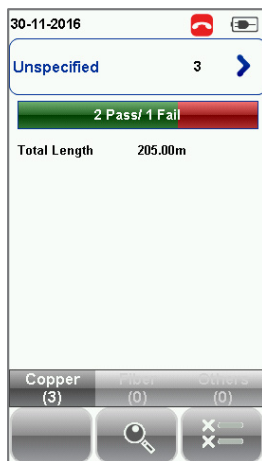

View Results

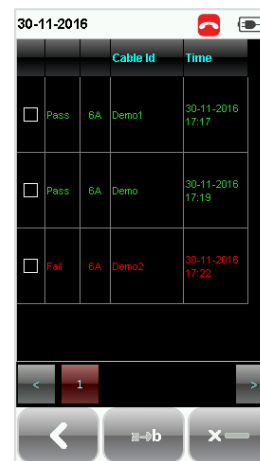

Manage Results



## CAUTION

Deleting a site will also delete its containing test results.



#### 4.2.4 The [TOOLS] button



The [TOOLS] button provides advanced options for in-depth troubleshooting and expert WireXpert users. These options include;-



Requires:  
LOCAL and REMOTE

**Set Reference** – Performs loss compensation through calculation from setting of referencing point.



Requires:  
LOCAL and REMOTE

**Length & Delay** – Performs a test to determine the length and propagation delay of each pair using the NVP value programmed by the user.



Requires:  
LOCAL and REMOTE

**Wiremap** – Verifies end-to-end wire mapping of cable.



Requires:  
LOCAL and REMOTE

**Learn NVP** – Performs a test to determine the NVP of the cable using the length value programmed by the user



Requires:  
LOCAL and REMOTE

**Reset Probe** – Resets Perm. Link adapter usage count once a new link cord is in place



Requires:  
LOCAL and REMOTE

**About** – Displays worldwide contact information Softing.



#### Note

30 meters (100 feet) cable length is at least required to get a valid NVP value.

## 5 Setting Reference

It is necessary to perform a set reference measurement if the LOCAL and REMOTE units are being paired for the first time. If there is a mismatch in firmware versions or a set reference has not been performed, AUTOTEST will be denied, until these conditions are corrected. Please also verify before testing that calibrations are not expired.

### Note



Diagrams and images used are for illustration purposes only and do not represent suggested test values. Reference and test values vary to usage and condition.

To set reference,

1. Connect a Permanent Link adapter to the LOCAL unit.
2. Connect a Channel adapter to the REMOTE unit.
3. Connect the 2 units together using the patch cord provided in the kit.
4. Press the **[TOOLS]** button → **Set Reference**

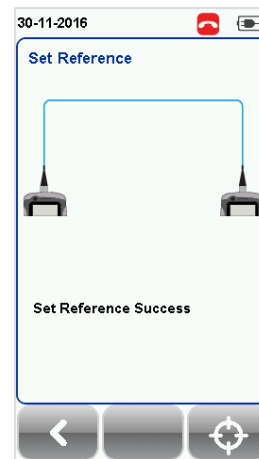
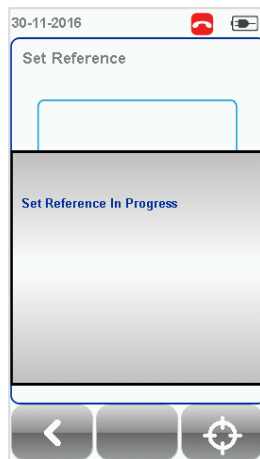
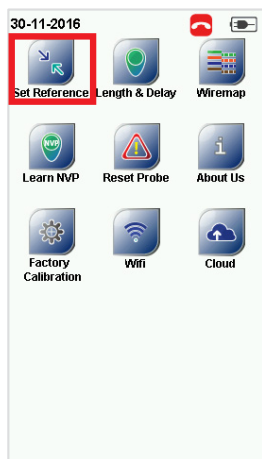

5. Set Reference will fail in the event of-

- Adapter probe mismatch, i.e., two channel or permanent link adapters
- Firmware version mismatch between LOCAL and REMOTE units
- No connection between LOCAL and REMOTE units





## 6 Configuring an AUTOTEST

### 6.1 Setting up WireXpert

After configuring the system settings, follow these steps to set up an AUTOTEST.

1. Press the **[SETUP]** button → **Project Settings**
  - a. **Site** – Create or select a Site
  - b. **Operator** – Create or select an Operator
  - c. **Label Source** – Select cable labelling scheme. Load labels from USB flash drive if using List Based Testing (LBT).
  - d. **AutoSave** – Enable option for WireXpert to auto save every PASS result.
2. Press the **[SETUP]** button → **Quick Setup** to select pre-defined test limit settings using matching generic UTP/FTP cable and FTP connector.
3. Manual Setup – Press the **[SETUP]** button → **Test Settings**
  - a. **Test Limit** – Select a test limit
  - b. **Cable** – Create a custom or select cable from list. Select **[Generic]** if unsure.
  - c. **Connector** - Create a custom or select connector from list. Select **[Generic]** if unsure.
  - d. **Test Options** → **General**
    - i. **Locator** – Enable option to display the worst NEXT and Return Loss (RL) fault information in an AUTOTEST result. Default has been set to OFF.
    - ii. **Cable Pairing Type** – Select if cable under test is paired using the T568-A or T568-B standard

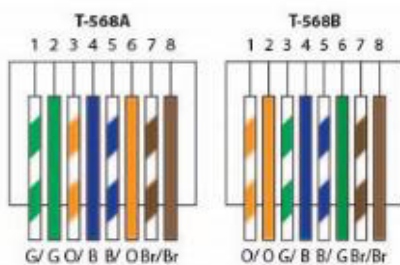

- iii. **Auto Test on Connection** – Enable option to perform AUTOTEST on, i.e, as soon as the connection between LOCAL and REMOTE units is established. Default option has been set to OFF.
- iv. **Direct Attach** – Enable option only if performing Direct Attach installation test. Default option has been set to OFF.
- v. **AC Wire map** – Enable option to bypass testing DC parameters. Default option has been set to OFF.

Please ensure you have the following components before conducting the test;

- WireXpert, LOCAL&REMOTE units (WX4500)

For Permanent Link Testing

- 2 x Permanent Link Adapter (WX\_AD\_6APL2)
- 2 x Patch Cord (WX\_AC\_6ALCORD2)

For Channel Testing

- 2 x Channel Adapter (WX\_AD\_6ACH2)



## CAUTION



Do not connect WireXpert to a voltage source such as an active telephone jack. Excessive voltage will damage the units and the adapter and void the warranty.

## 6.2 Testing Guide for Permanent Link Testing

Permanent Link (PL) test is comprised of the connection from a patch panel to a telecommunication outlet (horizontal cabling) using Permanent Link test adapters at each end of the link under test.

1. Insert the Permanent Link adapters into the LOCAL and REMOTE units of the WireXpert.
2. Power ON WireXpert. Check that WireXpert is in Copper testing mode.
3. Set reference is required if the units are being paired for the first time.
4. Choose the Permanent Link limits and configure other settings if necessary.
5. Connect the LOCAL unit to the patch panel and REMOTE unit to the outlet using the patch cord provided.
6. Press the **[AUTOTEST]** button to begin AUTOTEST.

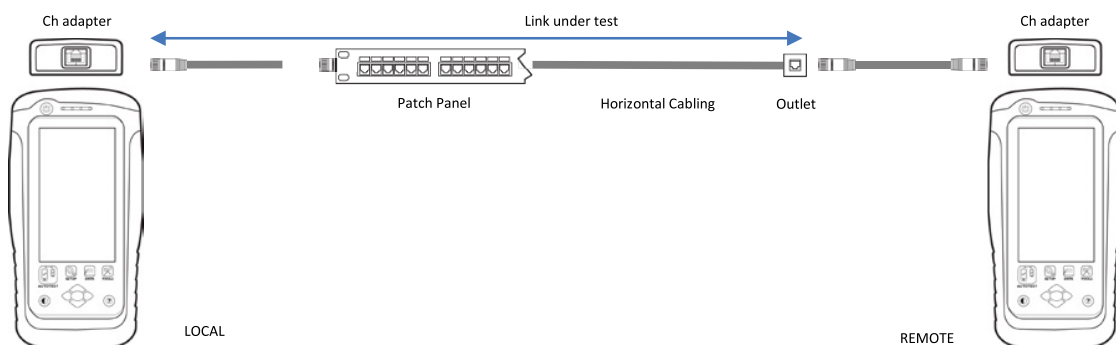

### 6.3 Testing Guide for Channel Testing

Channel (Ch) test is comprised of the connection from an active device (egg. Router) in a data rack, a telecommunication outlet (horizontal cabling) and the connecting patch cords at both ends using Channel test adapters at each end of the link under test. The recommended length for the patch cord from the patch panel and the outlet is 5m.

1. Insert the Channel adapters into the LOCAL and REMOTE units of the WireXpert.
2. Power ON WireXpert. Check that WireXpert is in Copper testing mode.
3. Set reference is required if the units are being paired for the first time. Refer to Chapter 2 on how to set reference.
4. Choose the Channel limits and configure other settings if necessary.
5. Connect the LOCAL unit to the patch panel and REMOTE unit to the outlet using the patch cord connected to be used.
6. Press the AUTOTEST button to begin AUTOTEST.

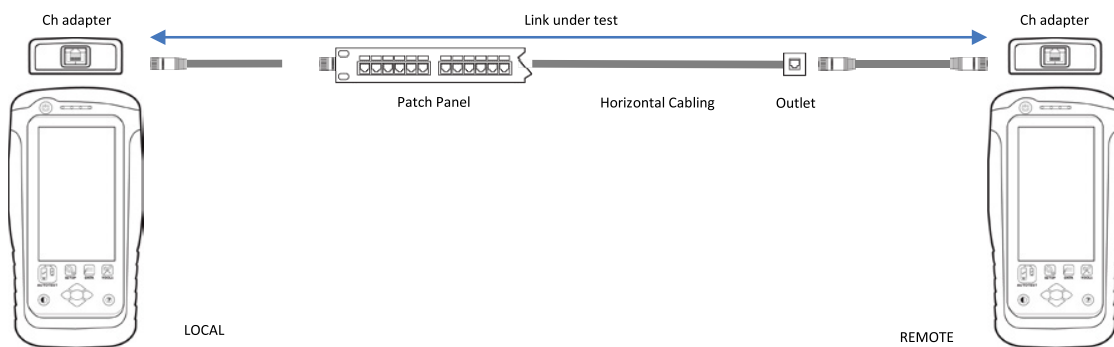

## 7 Performing an AUTOTEST

### 7.1 Understanding AUTOTEST

Press the **[AUTOTEST]** button once settings and limits have been selected. WireXpert will use the last configuration or factory settings to perform the AUTOTEST if new settings are not configured.

WireXpert will display summarized result with PASS or FAIL once AUTOTEST is completed. Press the **[View]** details button to view the comprehensive result or the **[Save]** button to save the results.



*AUTOTEST in progress*

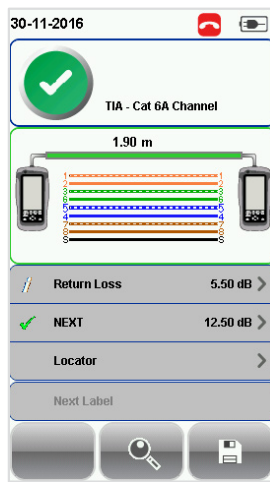

*AUTOTEST complete*

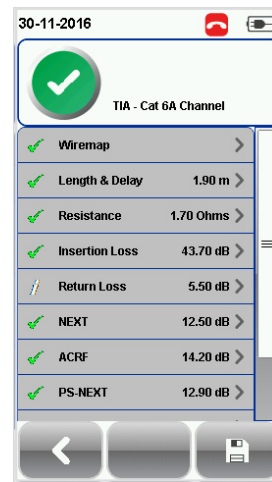

*[View] results*

Click on the parameter to display a more comprehensive individual result.

In plot view, press the **[Worst Margin]** button to view the worst margin. Press again to view the **[Worst Value]** or press the **[Manage]** button for more options.

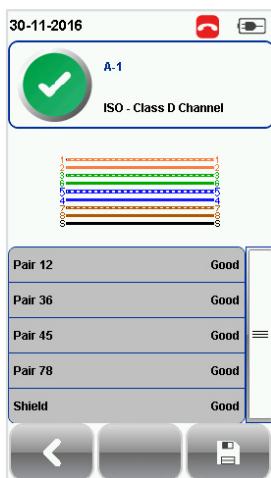

*Wire map*

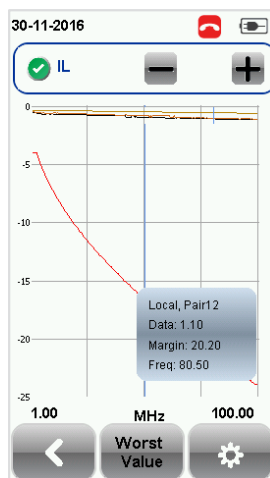

*Insertion Loss*

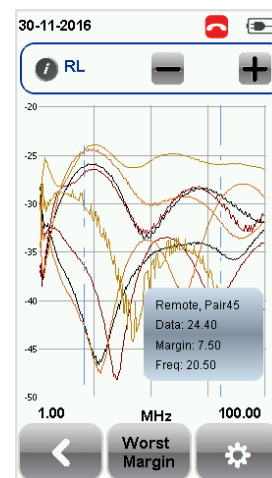

*Return Loss*

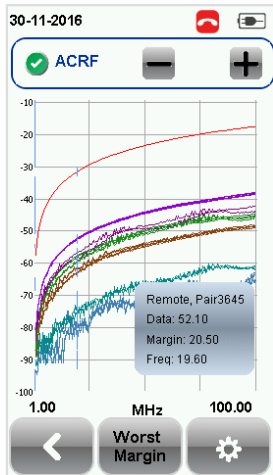

Attenuation to Crosstalk Ratio, Far-end

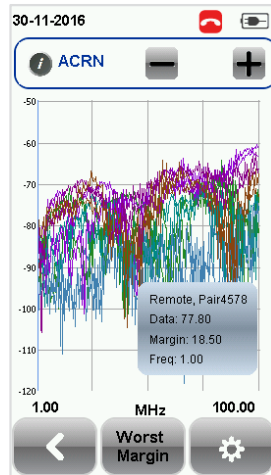

Attenuation to Crosstalk Ratio, Near-end (ISO only)

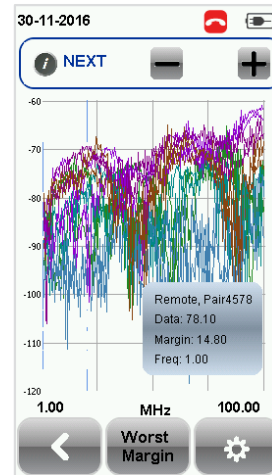

Near-end Crosstalk

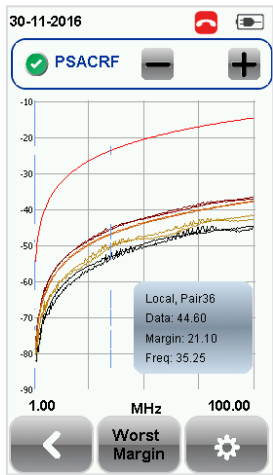

Power-sum ACRF

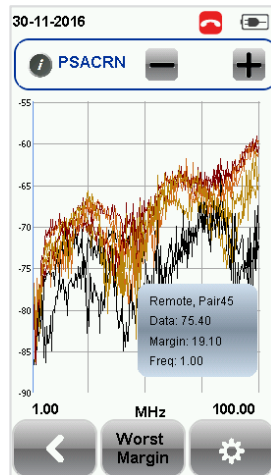

Power-sum ACRN (ISO only)

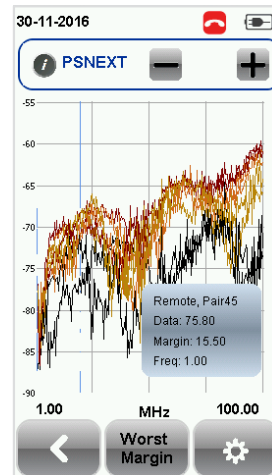

Power-sum NEXT

Manage plots

Pairs	Resistance
Pair 12	3.90 Ohms
Pair 36	2.60 Ohms
Pair 45	2.30 Ohms
Pair 78	20.30 Ohms
Δ	18.00 Ohms

Resistance

Pairs	Length(m)	Delay
Pair 12	2.70	15
Pair 36	2.60	14
Pair 45	2.60	14
Pair 78	2.70	15
OverAll	2.70	
Delay Skew		1

Length & Delay

## 7.2 NEXT and RL Fault Locating

If the Locator option is enabled in the **Test Settings** → **Test Options**, WireXpert will display extremely critical troubleshooting information in the form of a Time Domain Reflection plot for NEXT and Return Loss.

Near-End Crosstalk (NEXT) is an undesired effect of interference between two pairs in a cable measured at the same end of the cable as the interfering transmitter. In crosstalk, the signals traveling through adjacent pairs of wire in twisted-pair cabling interfere with each other. Cross talk is undesirable.

The NEXT Locator displays the locations where crosstalk is excessive in the cable and indicates the exact location in meters or feet from the LOCAL unit of where high crosstalk issue is seen. View individual plot by selecting/deselecting cable pairs. Each two pairs of cables that have been tested for crosstalk are represented by different colour in the plot.

Return Loss (RL) is the measurement (in dB) of the amount of signal that is reflected back toward the transmitter. Impedance mismatches and discontinuities caused by terminations to plugs or jacks and within the plug/jack connection itself contributes to RL. Excessive bends and damaged cable will also contribute to RL. The greater the variation in impedance, the greater the return loss reading.

The RL Locator displays the locations where return loss occurred during an AUTOTEST and indicates the exact location of where the highest return loss occurs. View individual plot by selecting/deselecting cable pair. Each pair of cables that has been tested is represented by different colour in the plot.

Each peak result in NEXT and RL Locator could represent a new joint connection, rarely a coupler and not necessary a bad cable that requires replacement.

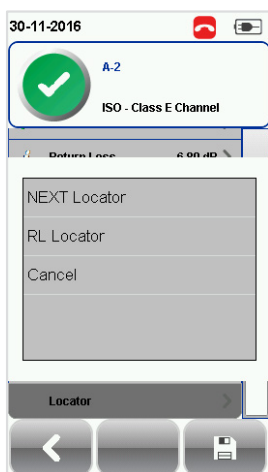

Locator – To enable, press the [SETUP] button → Test Settings → Test Options → Locator

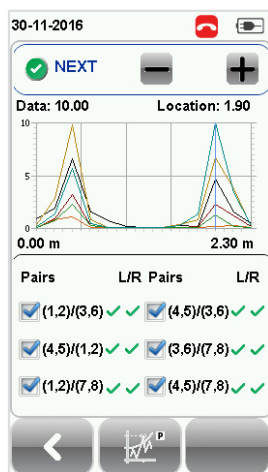

NEXT Locator

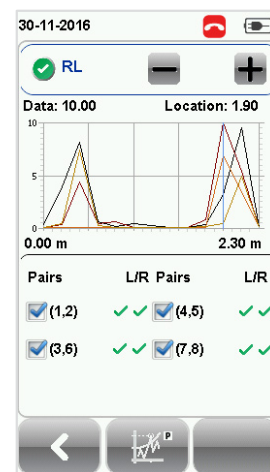

Return Loss Locator

### 7.3 Managing test result(s)

Test results can be manually saved by pressing the **[Save]** button after an AUTOTEST is completed. When prompted, enter label name and click **[OK]** to save.

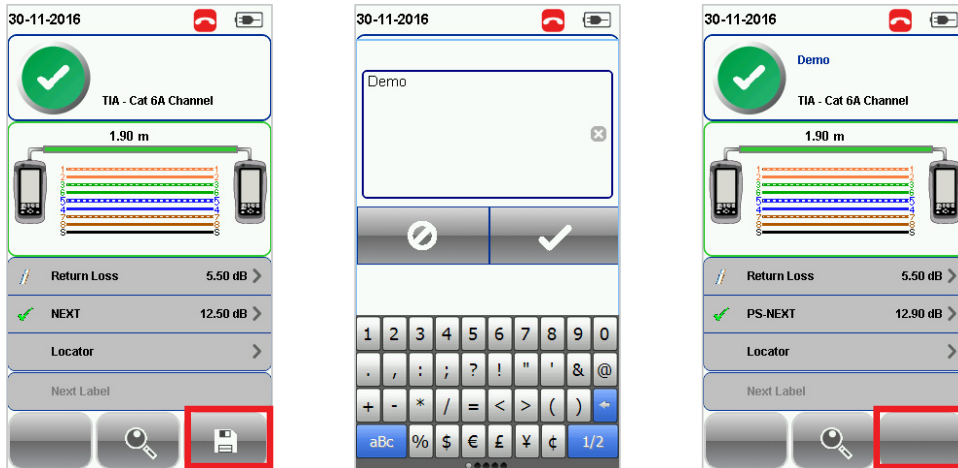

*The **[Save]** icon will disappear once saving is completed.*

Pass test results will be automatically saved with reference to the selected Label Source (**[SETUP]** → **Project Settings** → **Label Source**) when AUTOTEST is completed.



To view saved results,

1. Press the **[DATA]** button.
2. Select **[Copper]** and press the **[View]** button.
3. Select the test results click **[View]** to view results.
4. Select the next page for more results.

To delete a saved result,

1. Press the **[DATA]** button.
2. Select **[Copper]** and press the **[View]** button.

3. Press the **[Manage]** button.
4. Select result(s) and press the **[Delete]** to delete result(s).

To rename a saved result,

1. Press the **[DATA]** button.
2. Select **[Copper]** and press the **[View]** button.
3. Press the **[Manage]** button.
4. Select result and press the **[Rename]** to rename result.

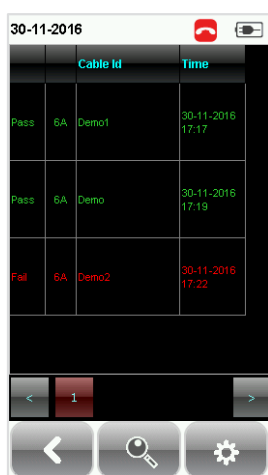
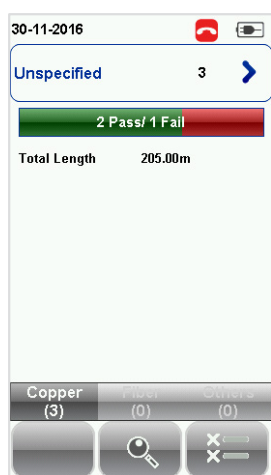

*View results*

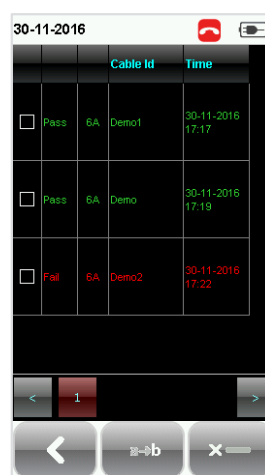

*Manage results*

## 7.4 Exporting test results into eXport PC Software

eXport is a data management software designed to work seamlessly with WireXpert. Saved results can be exported using the following methods;

### 7.4.1 USB Flash Drive

1. Insert USB flash drive to USB port on WireXpert.
2. Device will automatically detect flash drive.
3. Otherwise, press the **[SETUP]** button → **System Settings 2** → **Storage** → **USB**
4. Select **[Test Results]**.
5. Click **[OK]** to proceed.



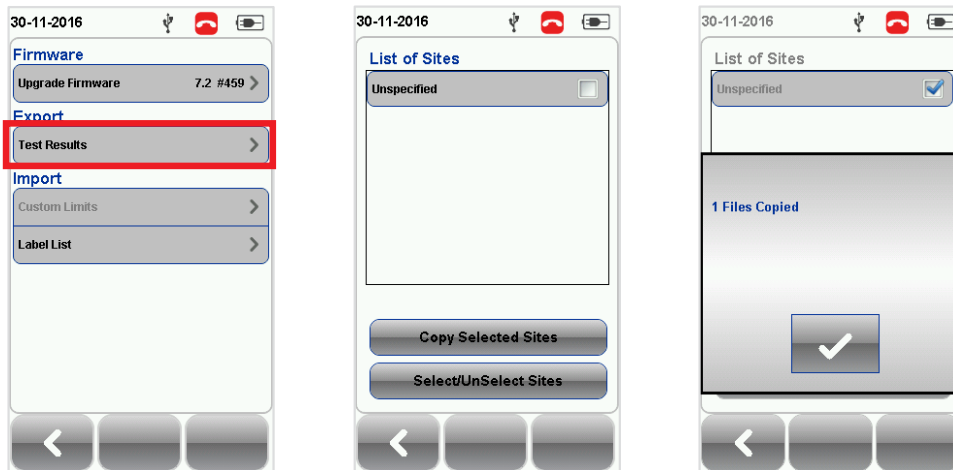

6. Launch eXport software.
7. Go to **File** → **Create New Project** to create new project space.
8. Go to **Import** → **USB Flash Drive** and select the flash drive. Click **[Import]**.
9. Select database and click **[Import Selected]** to import or click **[Import All]** for all databases.

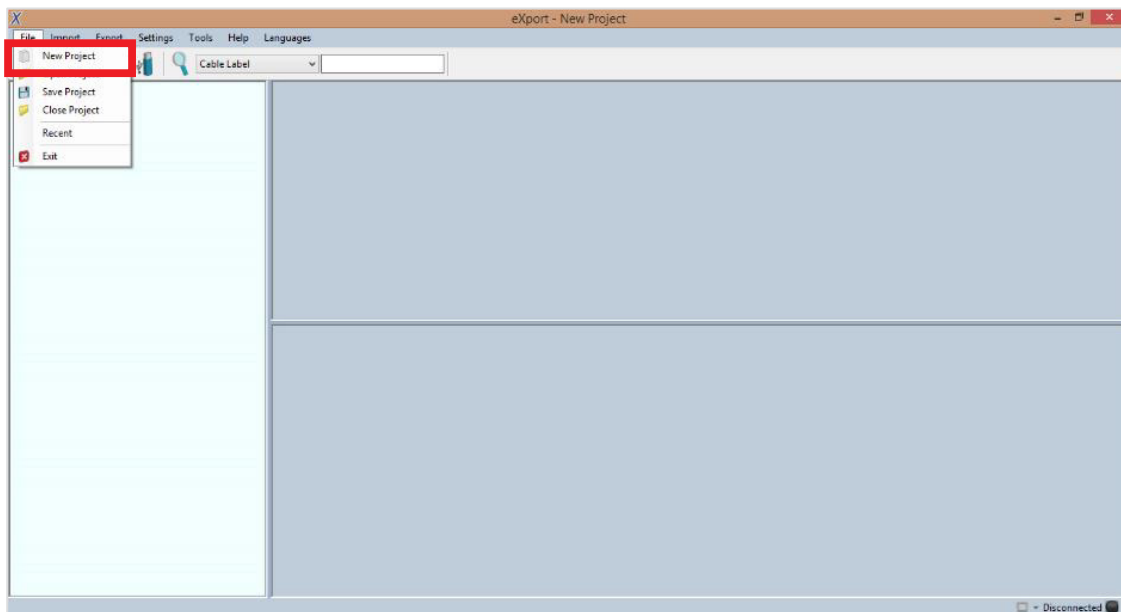

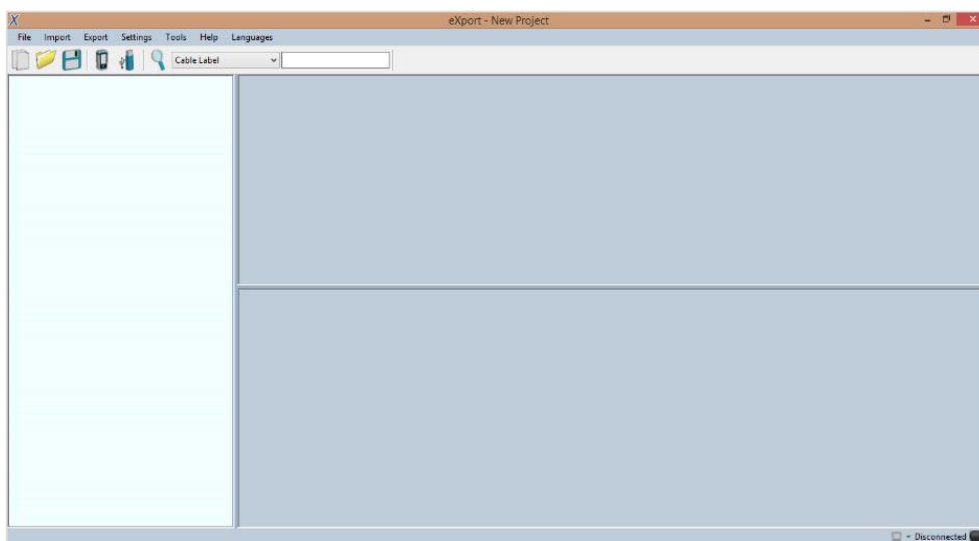
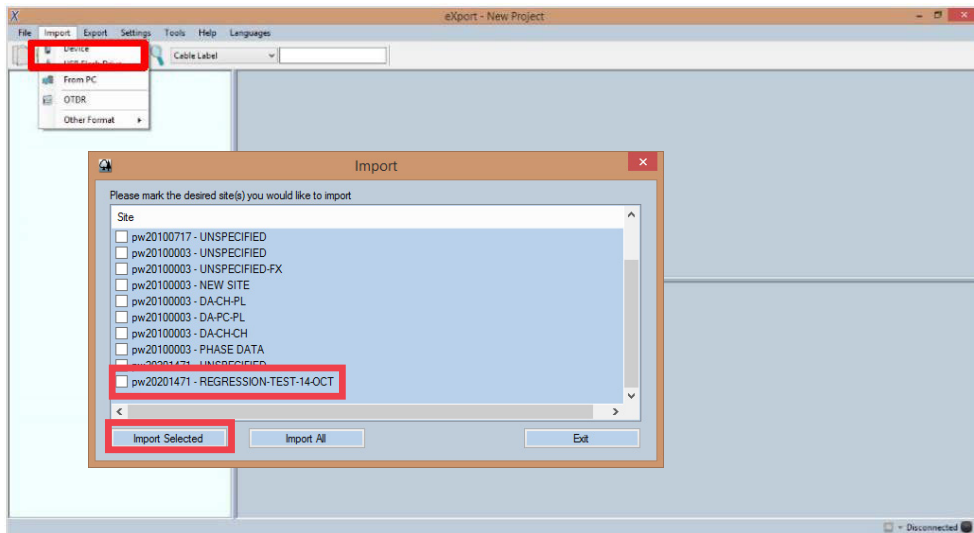
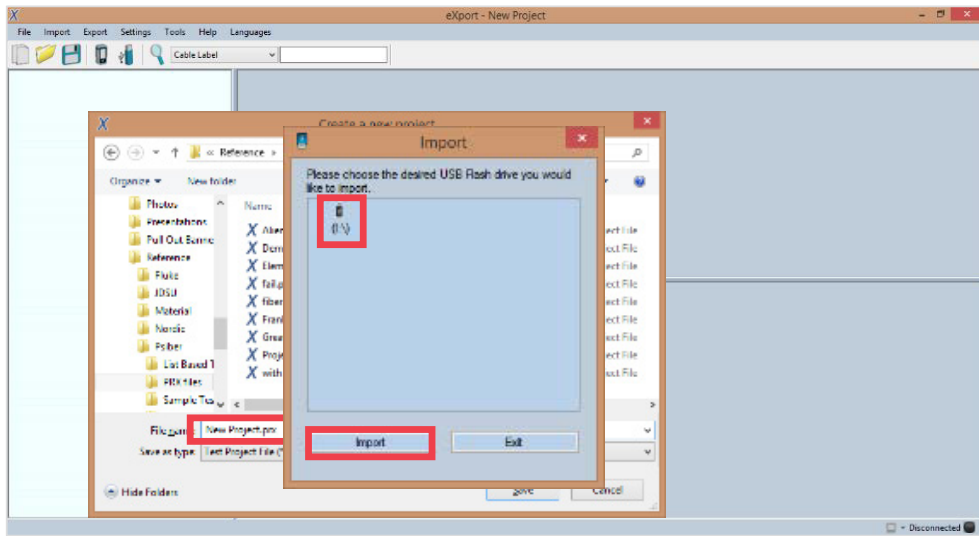

	Test Type	Device Type	Cable Label	Overall Result	Limit Type	Overall Length (m)	NEXT Margin (dB)	PL Margin (dB)	Time Stamp
1	Copper	Wx-4500	Science Park Building III_1_A	✓	ISO - Class D Channel	0.3	19.2	9.2	18-05-2015 02:...
2	Copper	Wx-4500	Science Park Building III_1_B	✗	ISO - Class D Channel	0.8	19.2	9.2	18-05-2015 02:...
3	Copper	Wx-4500	Science Park Building III_1_C	✗	ISO - Class D Channel	0	19.2	9.2	18-05-2015 02:...
4	Copper	Wx-4500	Science Park Building III_1_D	✓	ISO - Class D Channel	0.3	13.5	9.0	18-05-2015 02:...
5	Copper	Wx-4500	Science Park Building III_2_A	✓	ISO - Class D Channel	16.4	11.5	5.2	18-05-2015 02:...
6	Copper	Wx-4500	Science Park Building III_2_B	✗	ISO - Class D Channel	17.2	11.5	5.2	18-05-2015 02:...
7	Copper	Wx-4500	Science Park Building III_2_C	✗	ISO - Class D Channel	0.5	11.5	5.2	18-05-2015 02:...
8	Copper	Wx-4500	Science Park Building III_2_D	✓	ISO - Class D Channel	0.2	12.8	9.1	18-05-2015 02:...
9	Copper	Wx-4500	Science Park Building III_3_A	✓	ISO - Class D Channel	16.4	11.6	5.2	18-05-2015 02:...
10	Copper	Wx-4500	Science Park Building III_3_B	✗	ISO - Class D Channel	17.8	11.6	5.2	18-05-2015 02:...
11	Copper	Wx-4500	Science Park Building III_3_C	✓	ISO - Class D Channel	16.4	11.5	5.2	18-05-2015 02:...
12	Copper	Wx-4500	Science Park Building III_3_D	✓	ISO - Class D Channel	0.2	12.8	9.1	18-05-2015 02:...

Total Records: 12 Selected Record No: 1

## 7.4.2 Direct connection via USB cable

1. Connect WireXpert to your PC using a mini USB cable.
2. Launch eXport software.
3. Go to **File** → **Create New Project** to create new project space.
4. Go to **Import** → **Device**.
5. Select database and click **[Import Selected]** to import or click **[Import All]** for all databases.

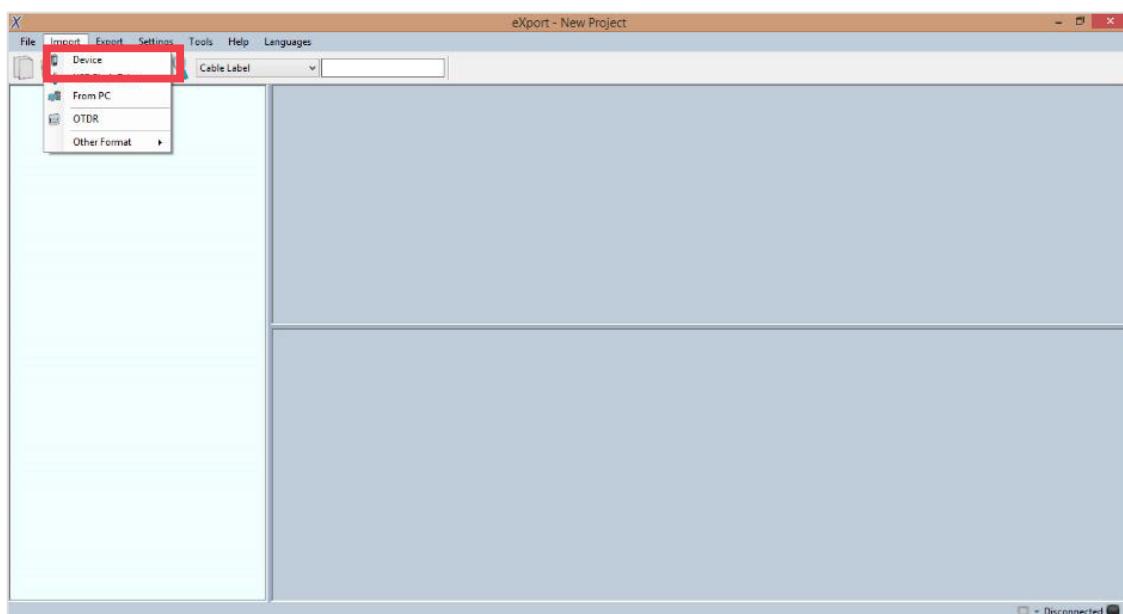

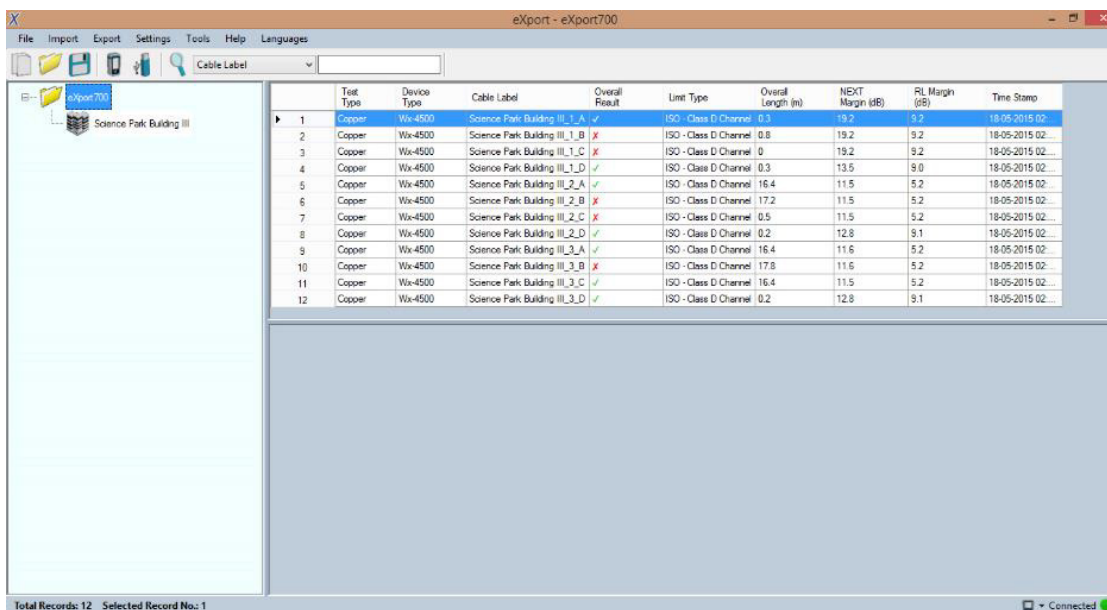
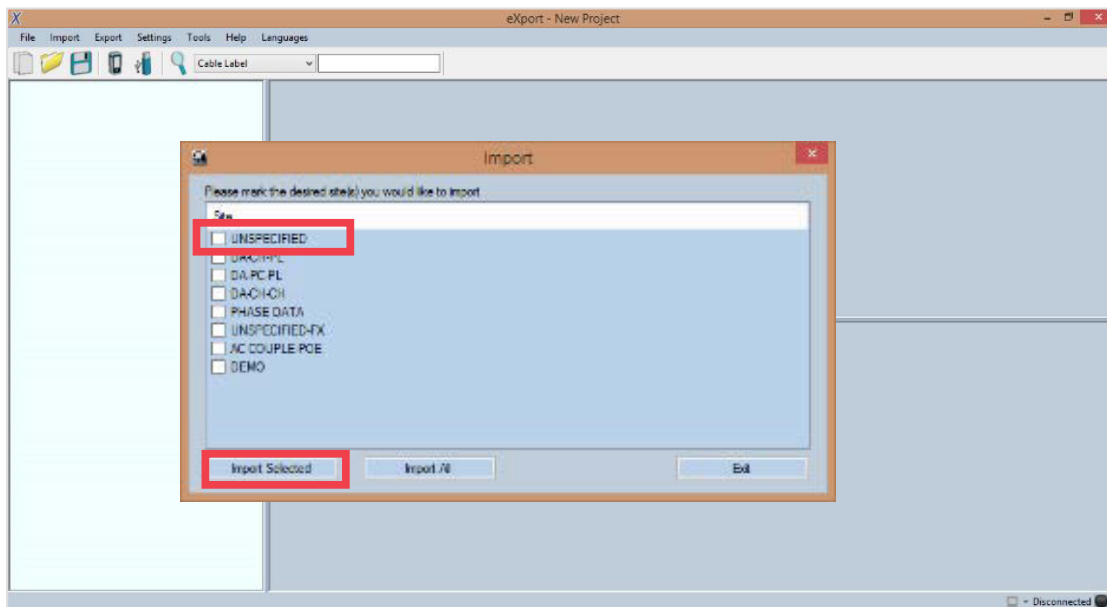

## User Manuals



Refer “User Manual – eXport” for more information on how to use the software.



## 8 Declarations

### EU Declaration of Conformity



We

Softing Singapore Pte. Ltd.  
3 Science Park Drive  
#03-09, The Franklin  
Singapore Science Park 1  
Singapore 118223

declare under our sole responsibility that the products

Model / Description

WX4500-FA	/	WireXpert cable certifier 2500 MHz
WX500-CU	/	WireXpert cable certifier 500 MHz
WX_AD_VCL_MM1/MM2	/	Multi mode fibre adapter
WX_AD_EF_MM1/MM2	/	Multi mode fibre adapter (encircled flux compliant)
WX_AD_SM1/SM2	/	Single mode fibre adapter
WX_AD_MM_MPO_KIT/ SOURCE/PWRMETER	/	Multi mode MPO adapters

including associated accessories and cables supplied by Softing Singapore, comply with the requirements of the following directives:

**EMC directive 2014/30/EU**

**Low Voltage Directive 2014/35/EU**

**RoHS directive 2011/65/EU**

**REACH Regulation (EC) 1907/2006 including tracking changes to the SVHC list published by ECHA on an ongoing basis. As of 21<sup>st</sup> February 2017, 173 SVHCs are listed.**

Applied harmonised standards:

**EN 55024 (2003-10) : Information technology equipment – Immunity characteristics – Limits and methods of measurement**

**EN 55022 (2008-05) : Information technology equipment – Radio disturbance characteristics – Limits and methods of measurement**

**IEC 60950-1:2005 (Second Edition) + Am 1:2009 + Am 2:2013 : Information technology equipment – Safety – Part 1 : General requirements**

Simon Harrison  
General Manager

21<sup>st</sup> February 2017

Date

This device complies with the requirements of the EC directive 2004/108/EG “Electromagnetic Compatibility” (EMC directive). It meets the following requirements:

## Note



A Declaration of Conformity in compliance with the above standards has been made and can be requested from Softing Singapore Pte Ltd.

## China ROHS



The WireXpert device and its test components are China ROHS compliant.

## WEEE



Electrical and electronic equipment must be disposed of separately from normal waste at the end of its operational lifetime. Please dispose of this product according to the respective national regulations or contractual agreements. If there are any further questions concerning the disposal of this product, contact Softing IT Networks.

## CAUTION



This is a Class A product. In a domestic environment this product may cause radio interference. In that case the user may be required to take adequate measures!

## ROHS



The WireXpert device and its test components are ROHS compliant.



#### ETL Intertek Verified



Intertek

WireXpert device is ETL verified to ANSI/TIA IIIe, IEC 61935-1 levels IIIe & IV and currently proposed Level V draft, with the applicable measurement accuracy.

#### Class 1 Laser Product



The light source transmitted from the following fiber test modules – Single Mode (SM), Multi-Mode (MM) and Encircled Flux compliant Multi-Mode (MMEF) are classified as Class 1 lasers and are very low risk and “safe under reasonably foreseeable use”, including the use of optical instruments for intrabeam viewing.

#### Class 1m Laser Product









The light source transmitted from the following fiber test modules – MPO REMOTE are classified as Class 1m lasers and have wavelengths between 302.5 nm and 4000 nm, and are safe except when used with optical aids.

## 9 Appendix

 <p><b>[Add]</b>– Adds a site, operator or customised cable, connector to the database.</p>	 <p><b>[Retest]</b> – Performs an AUTOTEST on selected result on List-Based Testing.</p>	 <p><b>[Back]</b> – Returns to previous screen. Unsaved options will be discarded.</p>
 <p><b>[Cancel]</b> – Discards option.</p>	 <p><b>[Delete]</b> – Deletes a site, operator or customised cable, connector from the database.</p>	 <p><b>[View]</b>– View selected result.</p>
 <p><b>[Manage]</b> – Enables <b>[Rename]</b> and <b>[Select all]</b> options.</p>	 <p>Format, Reset – Performs non-reversible setting/ data restoration to factory defaults.</p>	 <p>Forward – Proceed to the next screen.</p>
 <p><b>[Device info]</b> – Displays device firmware build information.</p>	 <p><b>[OK]</b> – Confirms and saves current option.</p>	 <p><b>[Rename]</b> – Renames saved test result in the DATA menu.</p>
 <p><b>[Restart]</b> – Restarts current procedure.</p>	 <p><b>[Save]</b> – Saves current test result. Icon will disappear after a successful save.</p>	 <p><b>[USB]</b> – Reads USB flash drive to perform upgrade firmware, test result export or custom limit and label list import</p>



 <p><b>[Select all]</b> – Selects all data on screen.</p>	 <p><b>[Next pair]</b> – View next pair of plots of the current result.</p>	 <p><b>Fibermap</b> – Displays mapping of fiber being tested.</p>
 <p><b>[MPO chart/grid]</b> – Toggles between displaying of power loss in bar chart or grid format for fiber testing.</p>	 <p><b>[Scope live/test]</b> – Toggles between 'Live' and 'Test' mode when inspecting a SM/MM fiber with the inspection scope.</p>	 <p><b>[Set Reference]</b> – Performs result referencing between the LOCAL and REMOTE units.</p>
 <p><b>[Transmit ON/OFF]</b> – Toggles between enabling and disabling of light source on the REMOTE unit.</p>		

## Related documents

User Manual – Fiber Certification Testing

User Manual – MPO Certification

User Manual – eXport

User Guide – List Based Testing

User Guide – Installing eXport PC Software

Quick Start Guide – Copper Certification Testing

Quick Start Guide – Fiber Certification Testing

Quick Start Guide – Encircled Flux Compliant Multimode Fiber Certification Testing

Quick Start Guide – MPO Certification Testing



### Disclaimer of liability

The information contained in these instructions corresponds to the technical status at the time of printing of it and is passed on with the best of our knowledge. The information in these instructions is in no event a basis for warranty claims or contractual agreements concerning the described products, and may especially not be deemed as warranty concerning the quality and durability pursuant to Sec. We reserve the right to make any alterations or improvements to these instructions without prior notice. The actual design of products may deviate from the information contained in the instructions if technical alterations and product improvements so require.

It may not, in part or in its entirety, be reproduced, copied, or transferred into electronic media.

Softing Singapore Pte Ltd

Singapore Science Park 1

3 Science Park Drive

Franklin, #03-09

Singapore 118223

<http://itnetworks.softing.com>

 + 65 6569 6019

 + 65 6899 1016

 [asia-support.itnetworks@softing.com](mailto:asia-support.itnetworks@softing.com)

The latest version of this manual is available in the Softing download area at:  
<http://itnetworks.softing.com>.

# 10 Technical Support

## THE AMERICAS

### Softing Inc.

7209 Chapman Highway  
Knoxville, TN 37920  
Phone: +1 865 251 5252  
E-mail: sales@softing.us

## ASIA/PACIFIC

### Softing Singapore Pte. Ltd.

3 Science Park Drive  
#03-09, The Franklin  
Singapore Science Park 1  
Singapore 118223  
Phone: +65-6569-6019 ext. 105  
E-mail: asia-sales.itnetwork@softing.com

## EUROPE/MIDDLE EAST/AFRICA

### Softing IT Networks GmbH

Richard-Reitzner-Alle 6  
D-85540 Haar, Munich  
Phone: +49 89 45 656 660  
E-mail: info.itnetworks@softing.com

### Softing Italia Srl.

Via M. Kolbe, 6  
20090 Cesano Boscone (MI)  
Phone: +39 02 4505171  
E-mail: info@softingitalia.it

### Softing Shanghai

Room 208, Building 1, No 388, Tianlin Road  
Xuhui District, 200233  
Shanghai, China  
Phone: +86-21-54133123  
E-mail: china-sales.itnetwork@softing.com

### Softing SRL

87 Rue du Général Leclerc  
Creteil, Île-de-France  
94000 (Paris)  
Phone: +33 1451 72805  
E-mail: info.france@softing.com

### Austria

Buxbaum Automation GmbH  
Eisenstadt  
Phone: +43 2682 7045 60  
E-Mail: office@myautomation.at

Softing's global presence ensures our customers receives sales and technical support  
anywhere around the world. For more information :

<http://itnetworks.softing.com>

IT Networks

